



Thank you for choosing Wellsford Cabinetry!

This updated **Door Selection Guide** provides information on our offerings, price levels, minimum sizing, and dimensional details for standard doors. The guide highlights:

- 32 of our most popular wood doors
- 35 new wood door styles
- 37 new Alternative Material door styles

**Custom Door Styles:** Door styles can be created to suit specific requirements. If you have interest to match something specific, please contact the **order desk**. We will be happy to review how we can accommodate your request.

**Wood Species:** Most door styles are available in a variety of woods. These selections can be found on the wood species availability list found on page 0.19. Bamboo and rustic knotty selections will have some exceptions. Please refer to your sample library to determine the possible finishes for each door style. Many door styles have other wood species available on an as needed basis. Contact the **order desk** for your specific requirements.

**Overlays:** All wood door styles can be ordered in framed 1/2" standard overlay and frameless full overlay. Other overlays and insets are available as noted on the specification page for each door. Alternative Materials styles are frameless full overlay only.

**Inset:** A variety of inset options are available on most mortise & tenon door styles. Details are included on the specification page for each door. Inset doors have soft-close concealed hinges. Exposed hinges are available by quote only.

**Sizing:** Size restrictions for each door will vary. The minimum sizing is critical when small width cabinets are necessary in a design. In general, for below minimum widths, we try to maintain the framing size of the standard door and vary the left to right overlay. The maximum width for a single panel door is 24". Mortise & tenon doors over 24" wide will be 2 panel. For doors with side mount hinges, maximum width is 24". For top mount hinges, maximum width door is 48". Minimum heights are listed on each door style page, but may vary with hinging. The maximum height for a mortise and tenon door with a single panel is 48" high. Mortise and tenon doors over 48" high will be 2 panels to stay in warpage warranty. Mitered doors over 48" high will be 1 panel and will not be covered for warpage. The tolerance for any door or drawer front is +/- 1/32" in width and height.



**Mortise & tenon doors** typically have five details that determine the door style.

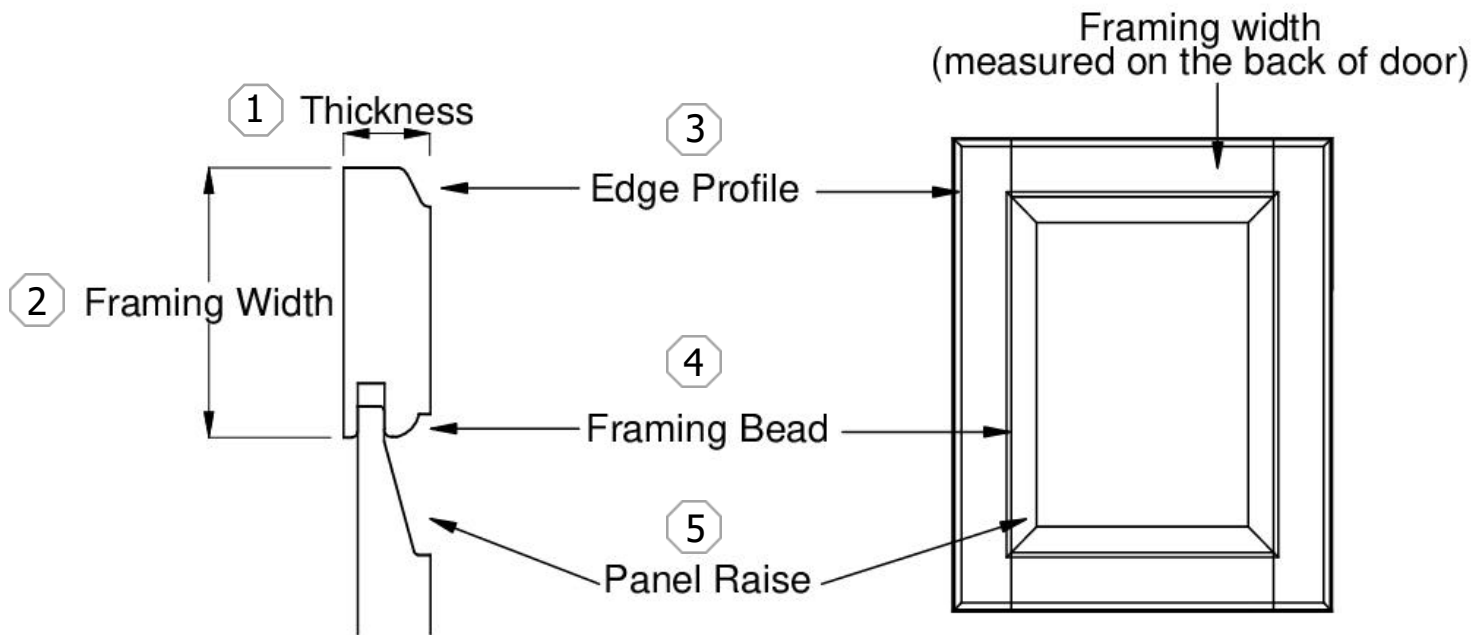

**Mitered door styles** cannot have custom framing width, edge profiles or framing beads. These details are part of the cutter that makes the door style. The panel raise can be customized.

Cannot be changed on mitered styles

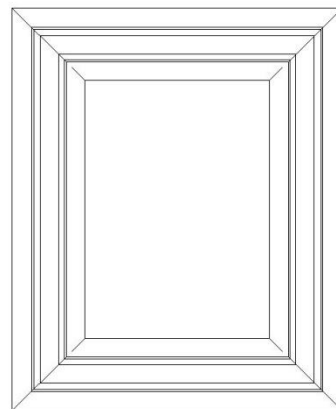
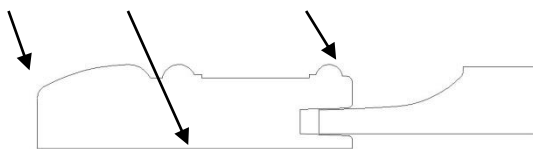

Given the nature of mitered products, multiple panel products such as wainscot are not available, nor are integral wainscot sides. Sometimes, a mortise and tenon design with some similar details can be used. Contact the **order desk** for assistance.



**Drawer heads:** Each door style is available with several drawer head designs shown on the specification page. Five piece drawer heads are available for most door styles. Some drawer heads are not available in 3/8" partial inset. It is possible to use a combination of drawer head styles by selecting Small Drawer Front designs (SDF), and Large Drawer Front designs (LDF) in the Quick Order Entry (QOE) software.

There are several options for framing of the drawer fronts in QOE. LDF styles should use "match door framing" to ensure panel alignment with adjacent doors. It is common for SDF styles to use "reduced top and bottom rails" to maximize the height of the center panel. Mitered SDF designs will typically have reduced framing that is style specific.





## NOTES



## Table of Contents

Door Style Index	i.vi
Wood Doors and Drawer Fronts	1.001
Alternative Materials	1.153
Wood Door Design Options	1.235



## Door Style Index

Alexandria	1.032	Churchill	1.130
Aluminum Frame	1.200	Colonial	1.008
Amesbury	1.034	Colony RE	1.010
Annapolis	1.036	Columbus	1.044
Aspen	1.100	Copenhagen	1.080
Astor	1.038	Crawford	1.064
Astoria	1.002	Crest	1.046
Augusta	1.040	Crossbuck	1.142
Austin	1.076	Daytona 225	1.164
Avalon	1.156	Daytona 300	1.166
Bahama	1.150	Delray 225	1.168
Barcelona	1.124	Delray 300	1.170
Bellevue	1.126	Dover	1.012
Berkley	1.042	Edgemont	1.104
Biltmore	1.078	Edgemont RE	1.106
Boca 225	1.158	Franklin	1.048
Boca 300	1.160	Georgia	1.082
Boulder	1.102	Hampton	1.014
Brandywine	1.128	Hudson	1.016
Bridgeport RE	1.004	Intrigue	1.220
Bristol	1.006	Key West	1.144
Brussels	1.062	Kingston	1.084
Cabo 225	1.162	Lasalle	1.032



Madison	1.086	Savannah	1.070
Melbourne225	1.172	Savoy	1.026
Melbourne 300	1.174	Shaker	1.050
Montego 225	1.176	Sorrento 225	1.188
Montego 275	1.178	Sorrento 300	1.190
Newport	1.018	Square Flat	1.028
Niagara	1.020	Square Raised	1.052
Nova RE	1.146	Stockholm	1.054
Old Forge	1.088	Strata	1.204
Olympia	1.022	Synchronicity – Mera	1.228
Oslo	1.090	Synchronicity – Vertro	1.230
Oxford	1.108	Tobago 225	1.192
Paris	1.066	Topeka	1.114
Plymouth	1.138	Veracruz225	1.194
Presidio	1.110	Veracruz275	1.196
Presidio RE	1.112	Verona	1.116
Prestwick	1.068	Vogue	1.212
Provencal	1.092	Wakefield	1.096
Quaker	1.024	Washington	1.056
Rio 225	1.180	Wayland	1.118
Rio 300	1.182	Westminster	1.072
Roma 225	1.184	Woodridge	1.120
Roma 300	1.186	Wright	1.058
Rosecliff	1.134		
Rutland	1.094		



## **Wood Door Styles by Level**

<b>Level 1</b>	<b>page</b>	<b>Level 2</b>	<b>page</b>
Astoria	1.002	Alexandria	1.032
Bridgeport RE	1.004	Amesbury	1.034
Bristol	1.006	Annapolis	1.036
Colonial	1.008	Astor	1.038
Colony RE	1.010	Augusta	1.040
Dover	1.012	Berkley	1.042
Hampton	1.014	Columbus	1.044
Hudson	1.016	Crest	1.046
Newport	1.018	Franklin	1.048
Niagara	1.020	Shaker	1.050
Olympia	1.022	Square Raised	1.052
Quaker	1.024	Stockholm	1.054
Savoy	1.026	Washington	1.056
Square Flat	1.028	Wright	1.058
		<b>Level 3</b>	
		Brussels	1.062
		Crawford	1.064
		Paris	1.066
		Prestwick	1.068
		Savannah	1.070
		Westminster	1.072





<b>Level 4</b>	<b>page</b>	<b>Level 6</b>	<b>page</b>
Austin	1.076	Barcelona	1.124
Biltmore	1.078	Bellevue	1.126
Copenhagen	1.080	Brandywine	1.128
Georgia	1.082	Churchill	1.130
Kingston	1.084	Lasalle	1.132
Madison	1.086	Rosecliff	1.134
Old Forge	1.088		
Oslo	1.090	<b>Level 7</b>	
Provencal	1.092	Plymouth	1.138
Rutland	1.094		
Wakefield	1.096	<b>Level 8</b>	
		Crossbuck	1.142
<b>Level 5</b>		Key West	1.144
Aspen	1.100	Nova RE	1.146
Boulder	1.102		
Edgemont	1.104	<b>Level 9</b>	
Edgemont RE	1.106	Bahama	1.150
Oxford	1.108		
Presidio	1.110		
Presidio RE	1.112		
Topeka	1.114		
Verona	1.116		
Wayland	1.118		
Woodridge	1.120		



## NOTES



# WOOD DOORS & DRAWER FRONTS

## LEVEL 1



## Astoria Level 1

<i>Framed</i>	<i>Frameless</i>	<i>Plywood</i>	<i>Furniture Board</i>	<i>Plain Inset</i>	<i>Beaded Inset</i>	<i>Full Overlay</i>	<i>Matching Drawer Front</i>	<i>Radius Door</i>	<i>Standard Hood Front</i>	<i>Concealed Hinge</i>	<i>Standard R.P. Arched Valance</i>	<i>Available Painted</i>	<i>Wainscot</i>
NA				NA	NA			NA	NA		NA	NA	NA

Notes:

- Specify horizontal or vertical grain.
- Sequential grain match available – max: 48" short grain, 96" long grain.
- Order hardwood parts with L034 edge to match profile.
- Available wood species: bamboo, cherry, hard maple, rift cut white oak, walnut.
- Mullions not available in veneered doors. Suggest 1-lite (frame only) glass door in Amesbury, Bristol or Quaker.
- Mullion doors in Quaker only.

Minimum Size: 2-1/2"w x 6"h (max 48" x 96")

Section Drawings of options available:

MDF Availability		
1 PC	2 PC	5 PC
NA	NA	NA

## Level 1

### Astoria

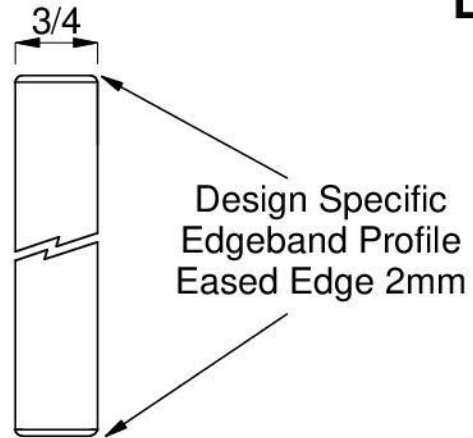
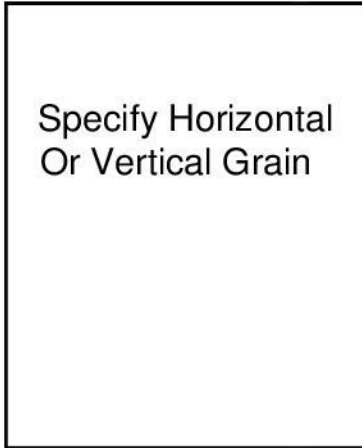

### Slab

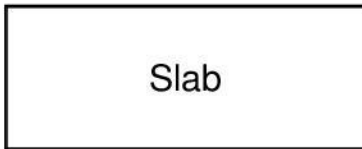

Specify Horizontal  
Or Vertical Grain

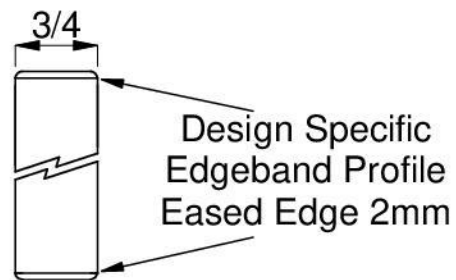



## Bridgeport RE Level 1

Framed	Frameless	Plywood	Furniture Board	Plain Inset	Beaded Inset	Full Overlay	Matching Drawer Front	Radius Door	Standard Hood Front	Concealed Hinge	Standard R.P. Arched Valance	Available Painted	Wainscot
								NA					

Notes:

Mullions not available.

Suggest mullion glass doors in Quaker door style (3/8" recess ilo 9/32") or 1-lite (frame only) glass door.

Minimum Size: 7"w x 5"h

MDF Availability		
1 PC	2 PC	5 PC
		NA

Section Drawings of options available:

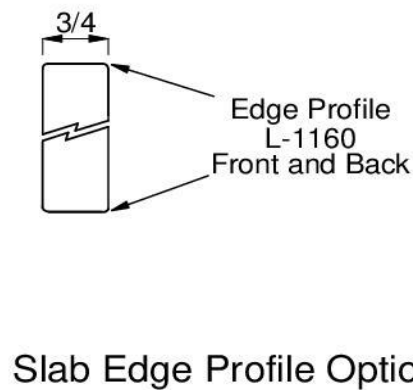
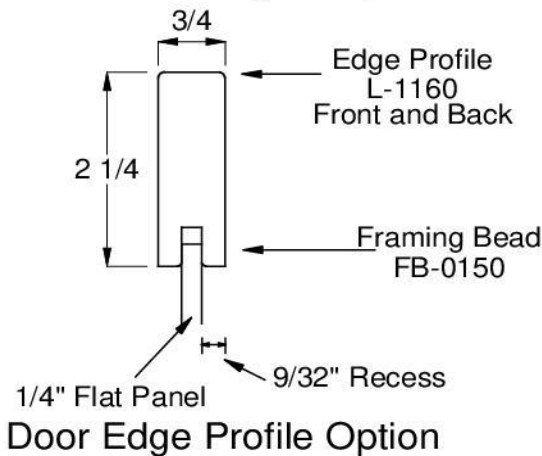

## Level 1

### Bridgeport RE

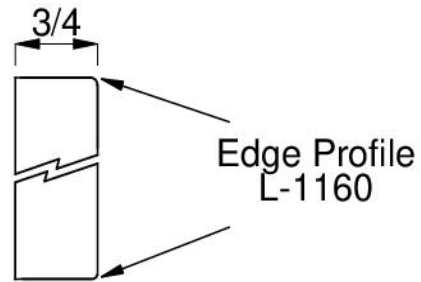
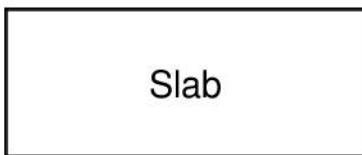
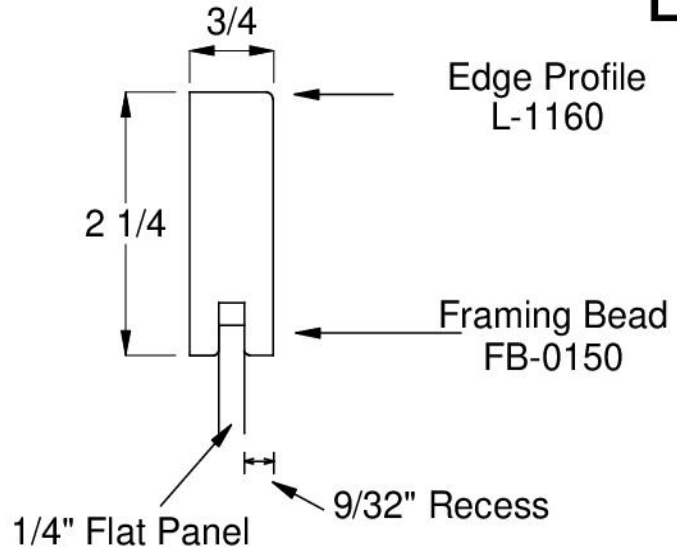
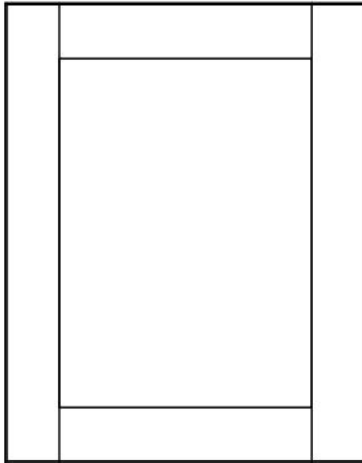

### Small Drawer Front with reduced rails 'SDF'

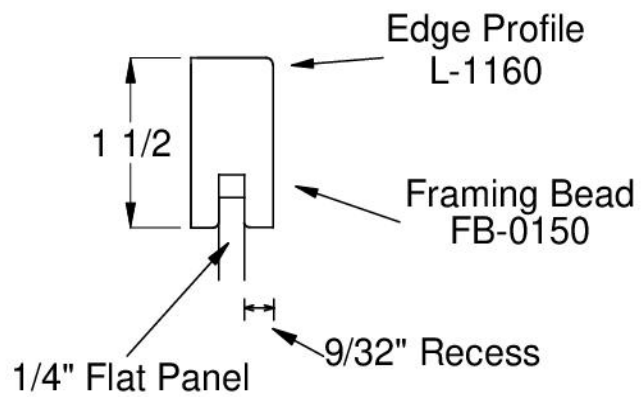
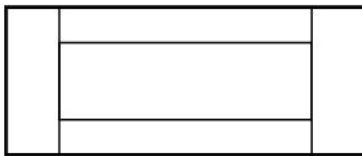

### Large Drawer Front match door framing 'LDF'

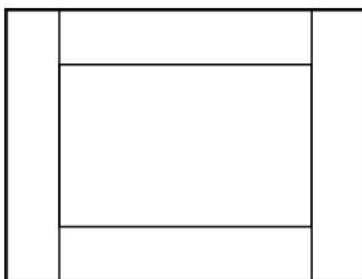

match door framing  
(see door detail above)



## Bristol Level 1

Framed	Frameless	Plywood	Furniture Board	Plain Inset	Beaded Inset	Full Overlay	Matching Drawer Front	Radius Door	Standard Hood Front	Concealed Hinge	Standard R.P. Arched Valance	Available Painted	Wainscot
								NA					

Notes:

Mullions not available.  
Suggest mullion glass doors in Quaker door style (3/8" recess ilo 9/32") or 1-lite (frame only) glass door.

Minimum Size: 7"w x 5"h

Section Drawings of options available:

MDF Availability		
1 PC	2 PC	5 PC
		NA



## Level 1

Bristol

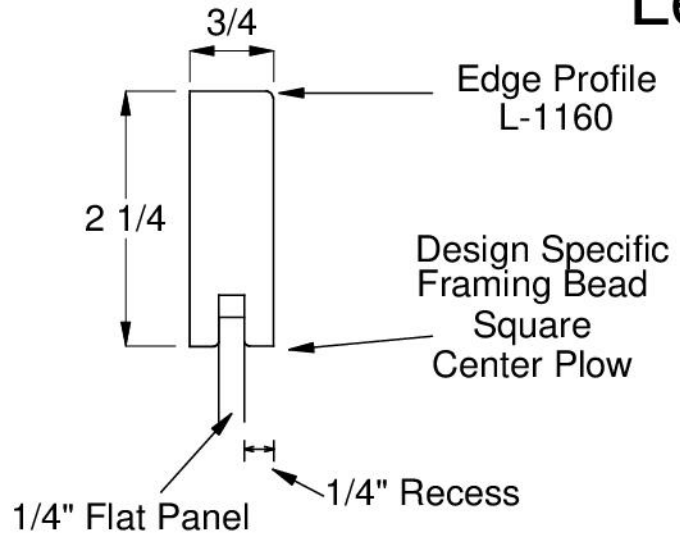
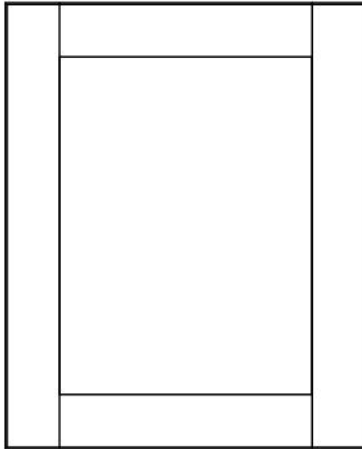

Slab

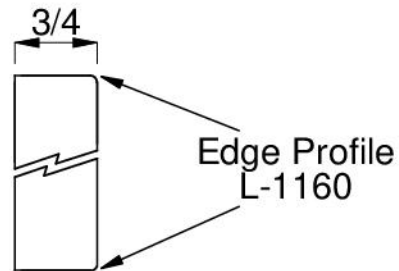
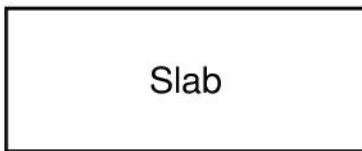

Small Drawer Front with reduced rails 'SDF'

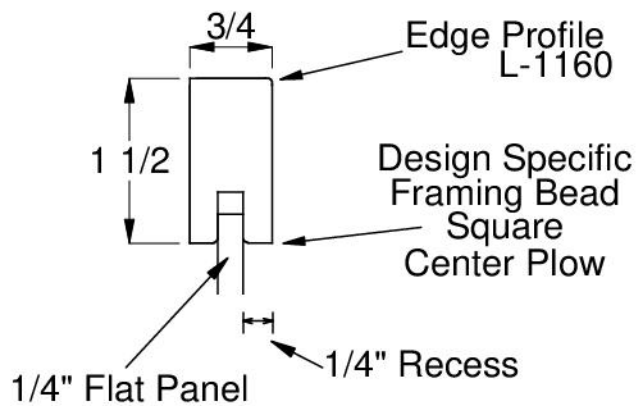
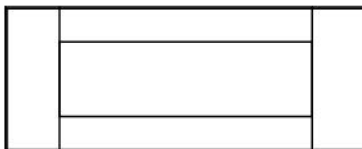

Large Drawer Front match door framing 'LDF'

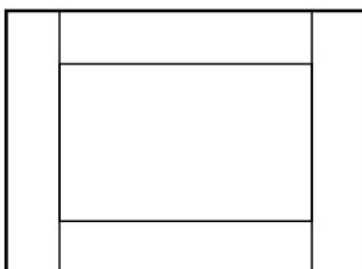

match door framing  
(see door detail above)



## Colonial Level 1

Framed	Frameless	Plywood	Furniture Board	Plain Inset	Beaded Inset	Full Overlay	Matching Drawer Front	Radius Door	Standard Hood Front	Concealed Hinge	Standard R.P. Arched Valance	Available Painted	Wainscot
								NA					

Notes:

Actual framing size may vary between 2-1/4" and 2-5/16" depending on vendor selected by Wellsford.

Minimum Size: 7"w x 5"h

Section Drawings of options available:

MDF Availability		
1 PC	2 PC	5 PC

## Level 1

### Colonial

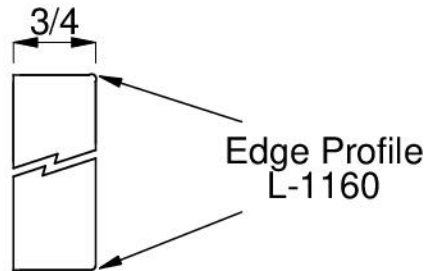
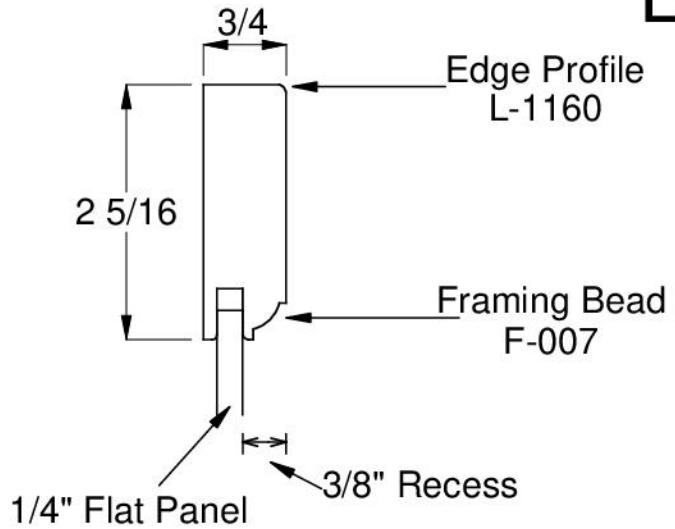
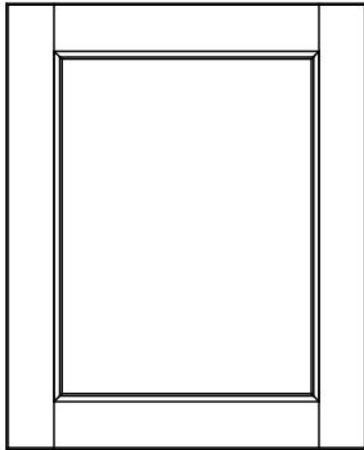

### Small Drawer Front with reduced rails 'SDF'

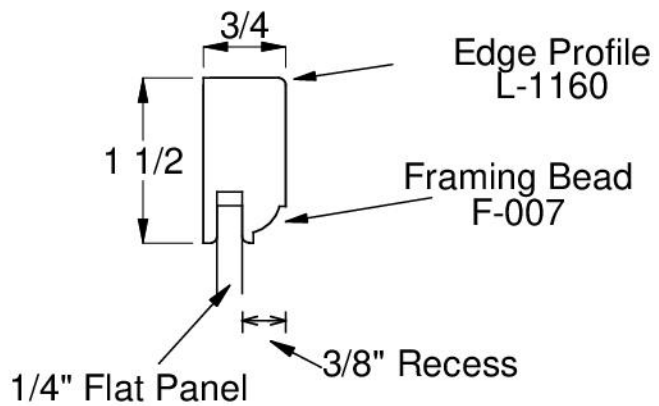
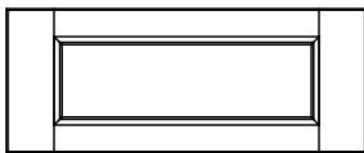

### Large Drawer Front match door framing 'LDF'

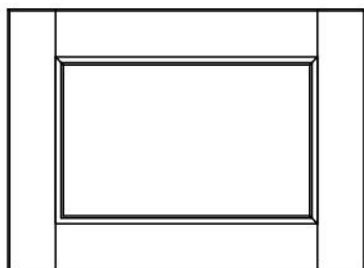

match door framing  
(see door detail above)



## Colony RE Level 1

Framed	Frameless	Plywood	Furniture Board	Plain Inset	Beaded Inset	Full Overlay	Matching Drawer Front	Radius Door	Standard Hood Front	Concealed Hinge	Standard R.P. Arched Valance	Available Painted	Wainscot
								NA					

Notes:

Matching mullion bead not available.  
Suggest mullion glass doors in Dover door style (3/8" recess ilo 1/4") or 1 lite (frame only) glass door

Minimum Size: 7"w x 5"h

MDF Availability		
1 PC	2 PC	5 PC
		NA

Section Drawings of options available:

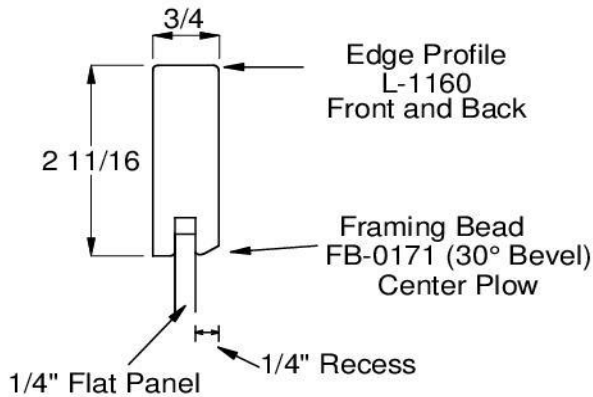

Slab Edge Profile Option

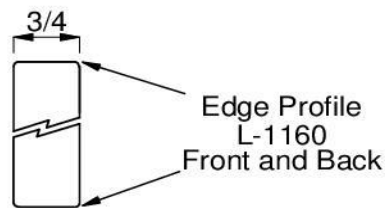

Slab Edge Profile Option

## Level 1

Colony RE

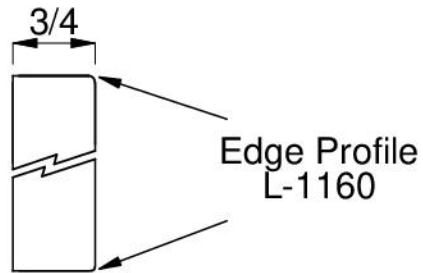
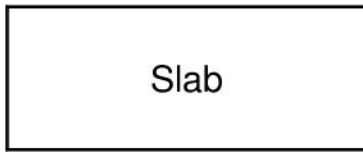
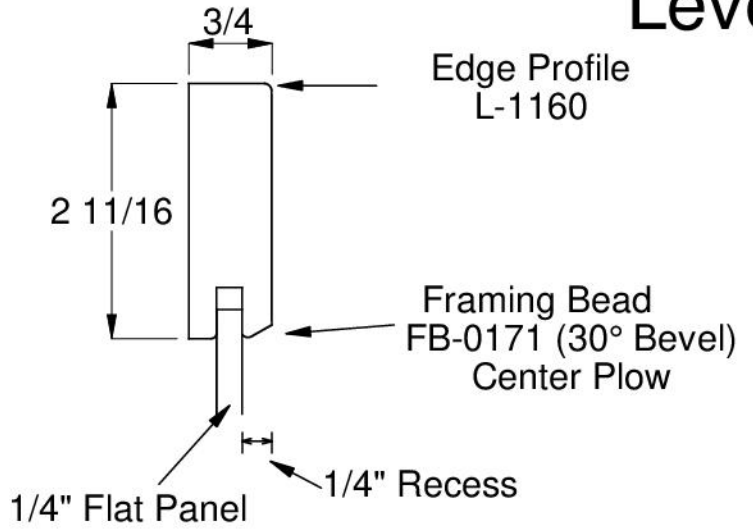
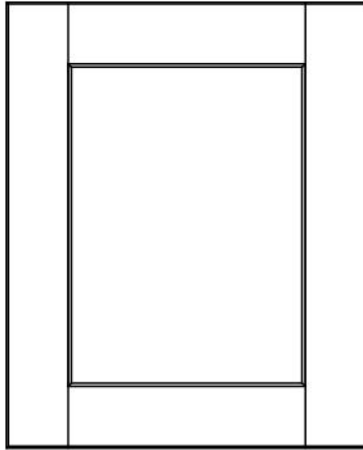

Small Drawer Front with reduced rails 'SDF'

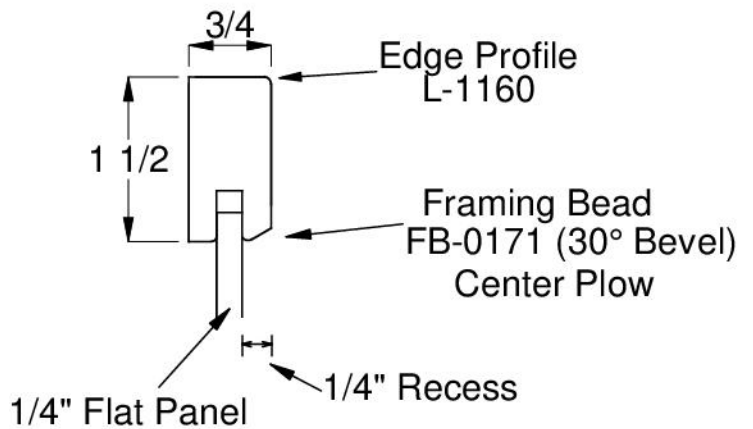
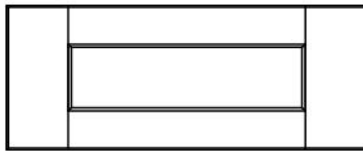

Large Drawer Front match door framing 'LDF'

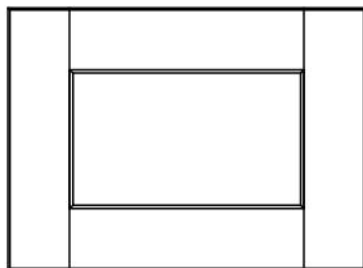

match door framing  
(see door detail above)



## Dover Level 1

Framed	Frameless	Plywood	Furniture Board	Plain Inset	Beaded Inset	Full Overlay	Matching Drawer Front	Radius Door	Standard Hood Front	Concealed Hinge	Standard R.P. Arched Valance	Available Painted	Wainscot
								NA					

Notes:

Actual framing size may vary between 2-1/4" and 2-5/16" depending on vendor selected by Wellsford.

Minimum Size: 7"w x 5"h

Section Drawings of options available:

MDF Availability		
1 PC	2 PC	5 PC

## Level 1

Dover

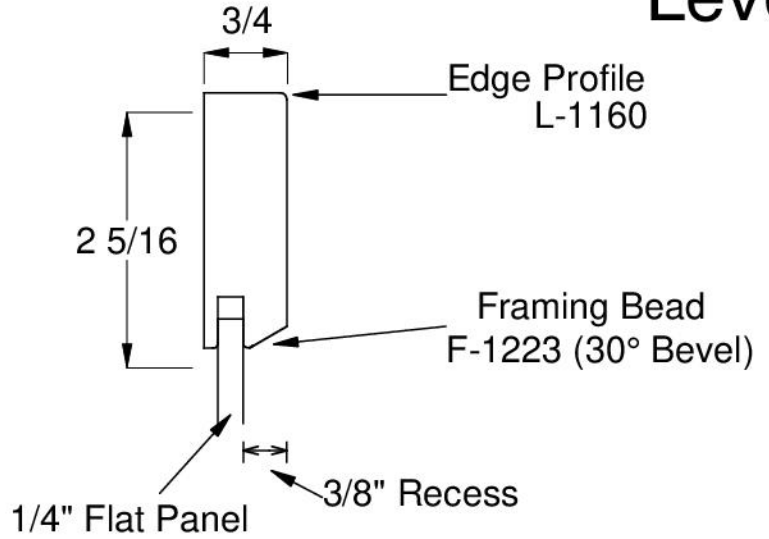
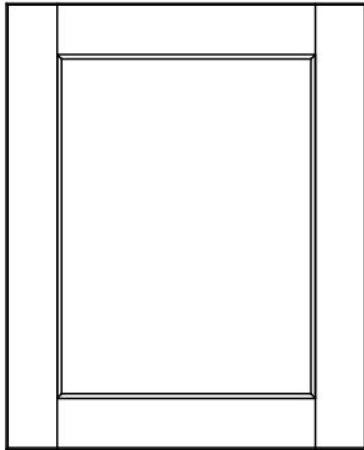

Slab

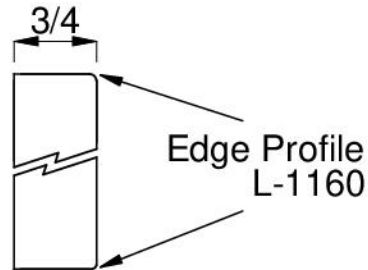
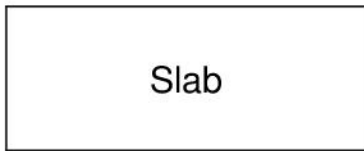

Small Drawer Front with reduced rails 'SDF'

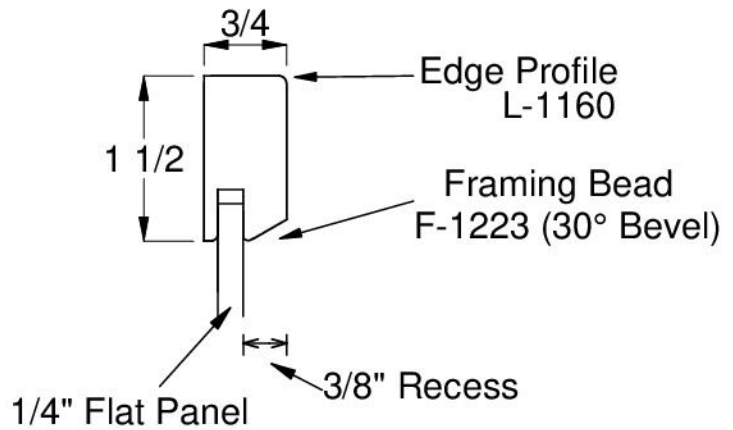
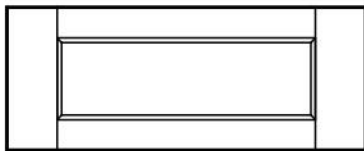

Large Drawer Front match door framing 'LDF'

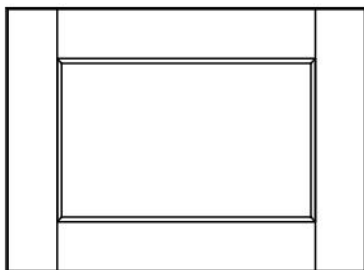

match door framing  
(see door detail above)



## Hampton Level 1

Framed	Frameless	Plywood	Furniture Board	Plain Inset	Beaded Inset	Full Overlay	Matching Drawer Front	Radius Door	Standard Hood Front	Concealed Hinge	Standard R.P. Arched Valance	Available Painted	Wainscot
							NA						

Notes:

Matching mullion bead not available.  
 Suggest regular bead or 1-lite (frame only) glass door.  
 Actual framing size may vary between 2-1/4" and 2-5/16"  
 depending on vendor selected by Wellsford.

Minimum Size: 7"w x 5"h

Section Drawings of options available:

MDF Availability		
1 PC	2 PC	5 PC



## Level 1

### Hampton

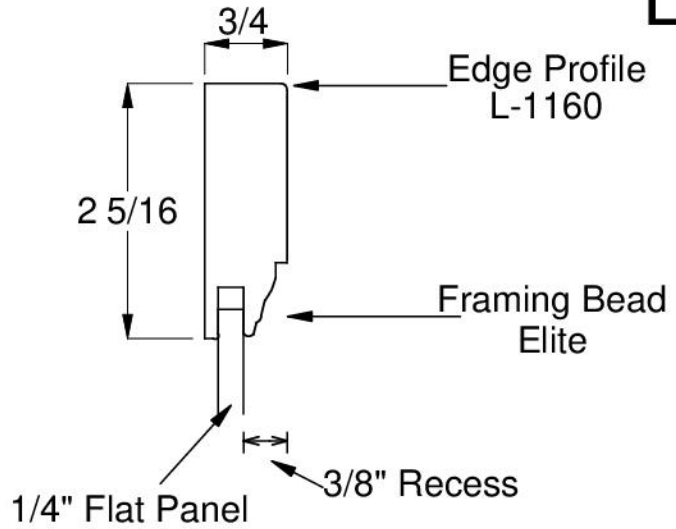
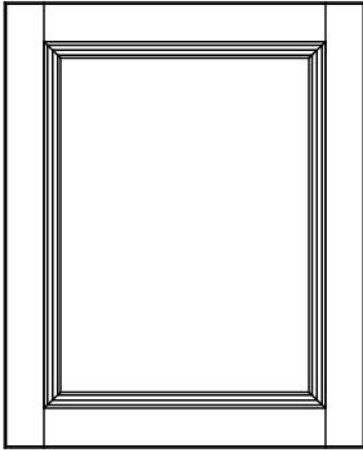

### Slab

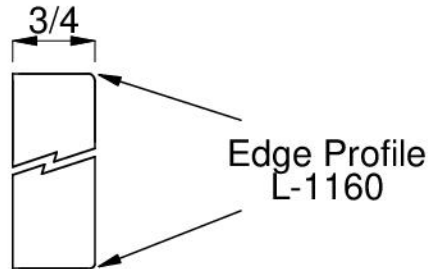
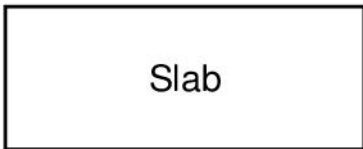

### Small Drawer Front with reduced rails 'SDF'

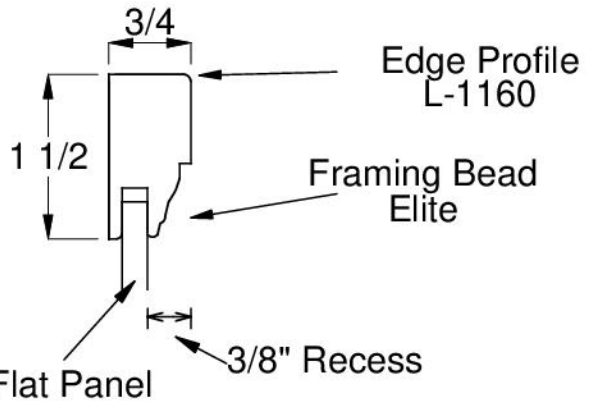
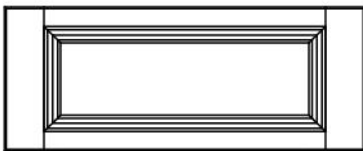

### Large Drawer Front match door framing 'LDF'

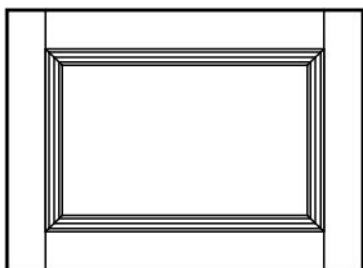

match door framing  
(see door detail above)



## Hudson Level 1

Framed	Frameless	Plywood	Furniture Board	Plain Inset	Beaded Inset	Full Overlay	Matching Drawer Front	Radius Door	Standard Hood Front	Concealed Hinge	Standard R.P. Arched Valance	Available Painted	Wainscot
								NA					

Notes:

Actual framing size may vary between 2-1/4" and 2-5/16" depending on vendor selected by Wellsford.

Minimum Size: 7"w x 5"h

Section Drawings of options available:

MDF Availability		
1 PC	2 PC	5 PC

## Level 1

Hudson

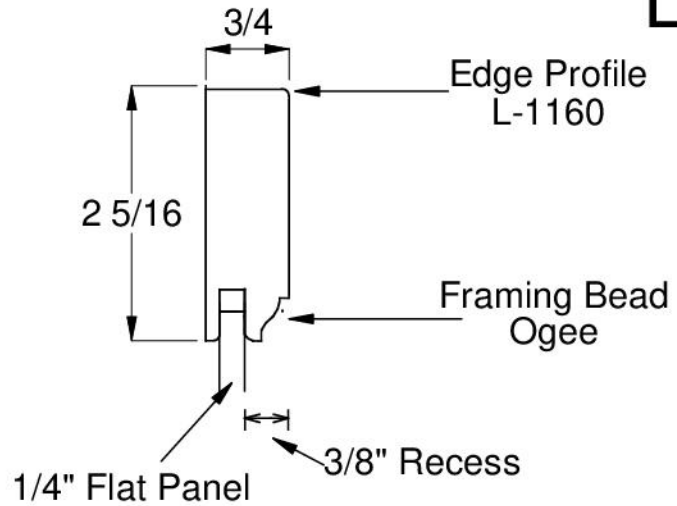
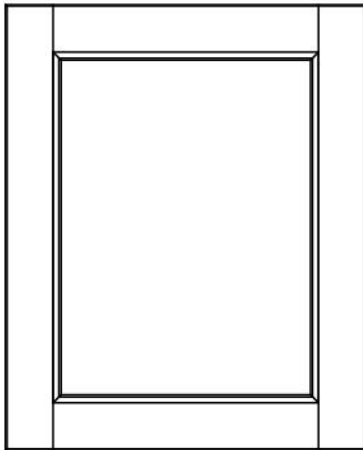

Slab

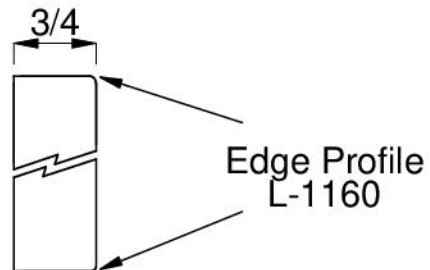
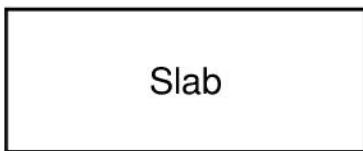

Small Drawer Front with reduced rails 'SDF'

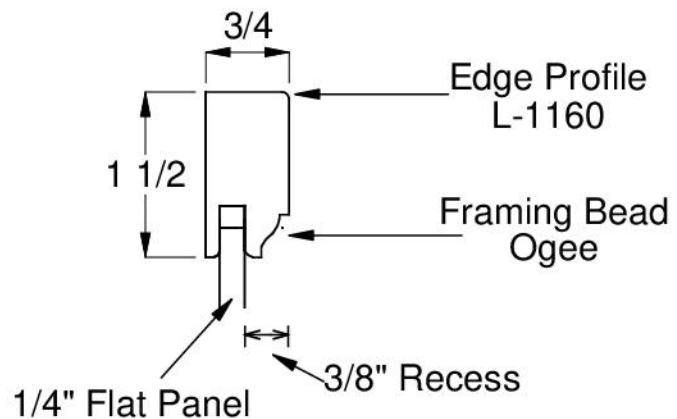
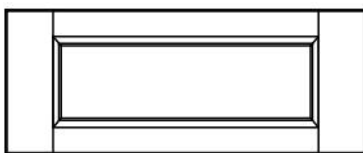

Large Drawer Front match door framing 'LDF'

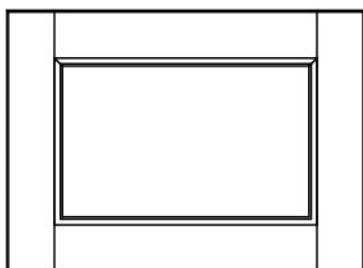

match door framing  
(see door detail above)



## Newport Level 1

Framed	Frameless	Plywood	Furniture Board	Plain Inset	Beaded Inset	Full Overlay	Matching Drawer Front	Radius Door	Standard Hood Front	Concealed Hinge	Standard R.P. Arched Valance	Available Painted	Wainscot
								NA					

Notes:

Actual framing size may vary between 2-1/4" and 2-5/16" depending on vendor selected by Wellsford.

Minimum Size: 7"w x 5"h

Section Drawings of options available:

MDF Availability		
1 PC	2 PC	5 PC
		NA

## Level 1

Newport

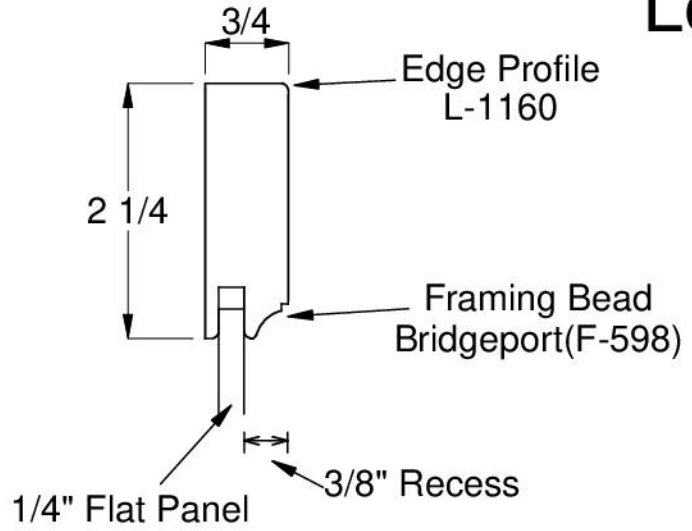
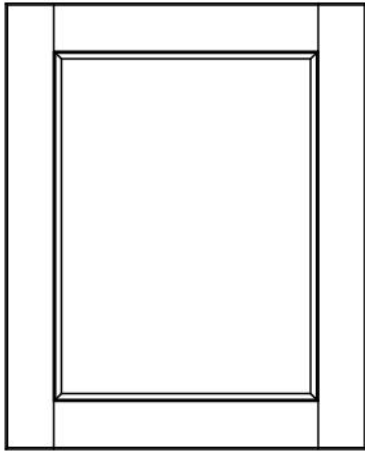

Slab

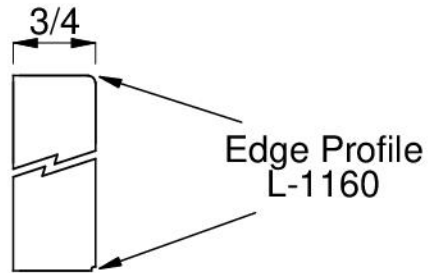
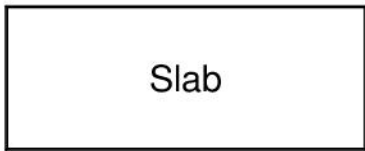

Small Drawer Front with reduced rails 'SDF'

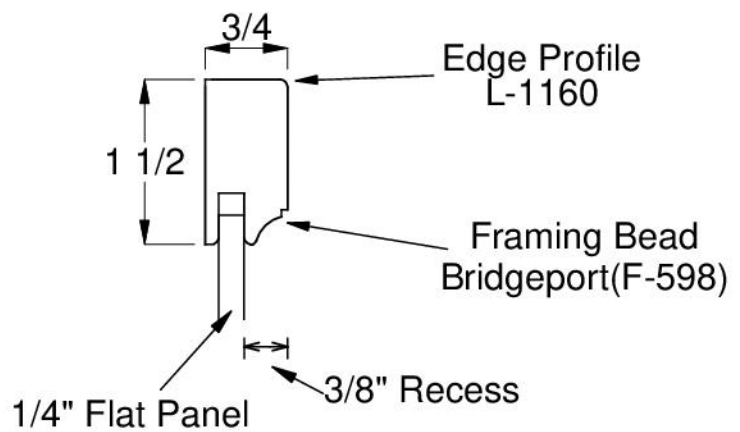
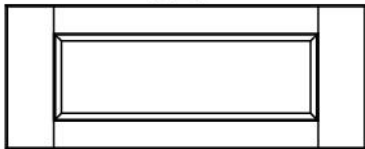

Large Drawer Front match door framing 'LDF'

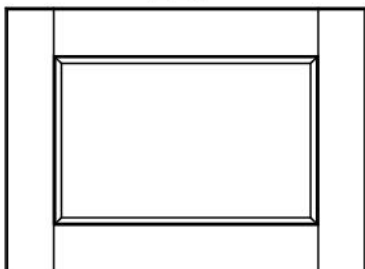

match door framing  
(see door detail above)



## Niagara Level 1

Framed	Frameless	Plywood	Furniture Board	Plain Inset	Beaded Inset	Full Overlay	Matching Drawer Front	Radius Door	Standard Hood Front	Concealed Hinge	Standard R.P. Arched Valance	Available Painted	Wainscot
								NA					

Notes:

Matching mullion bead not available –  
Suggest regular bead (see p. 1.160) or 1-lite (frame only) glass door.

Minimum Size: 7"w x 5"h

Section Drawings of options available:

MDF Availability		
1 PC	2 PC	5 PC
NA	NA	

## Level 1

Niagara

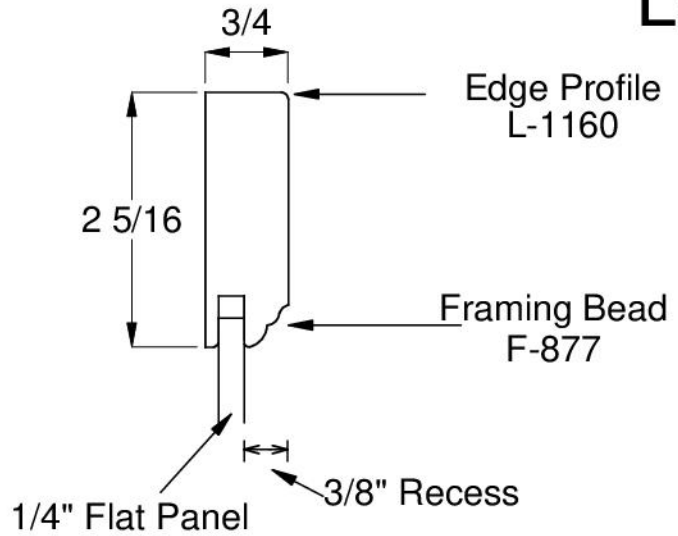
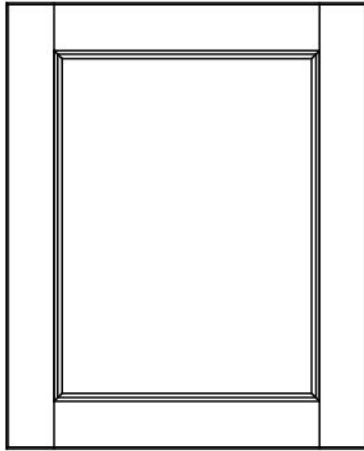

Slab

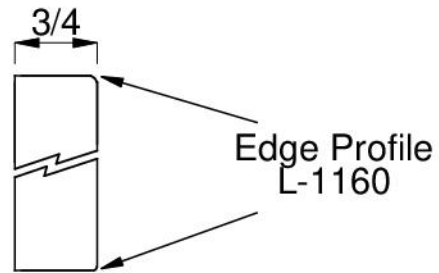
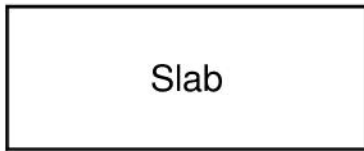

Small Drawer Front with reduced rails 'SDF'

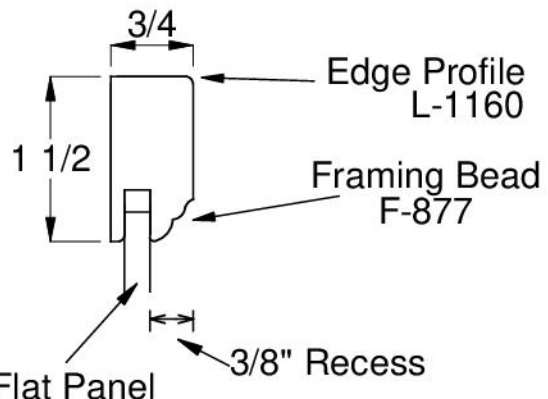
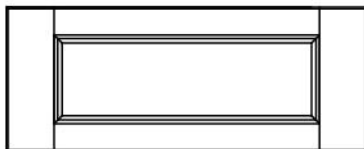

Large Drawer Front match door framing 'LDF'

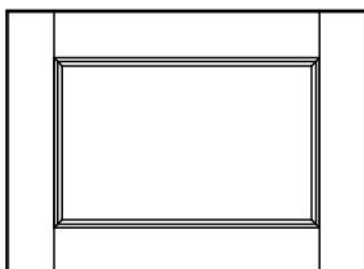

match door framing  
(see door detail above)



## Olympia Level 1

Framed	Frameless	Plywood	Furniture Board	Plain Inset	Beaded Inset	Full Overlay	Matching Drawer Front	Radius Door	Standard Hood Front	Concealed Hinge	Standard R.P. Arched Valance	Available Painted	Wainscot
								NA					

Notes:

Actual framing size may vary between 2-1/4" and 2-5/16" depending on vendor selected by Wellsford.

Minimum Size: 7"w x 5"h

Section Drawings of options available:

MDF Availability		
1 PC	2 PC	5 PC



## Level 1

Olympia

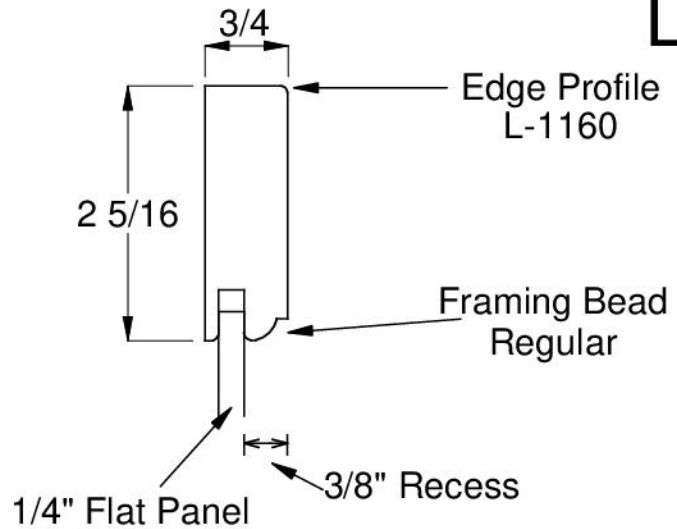
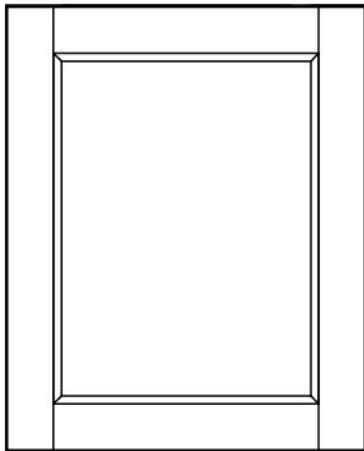

Slab

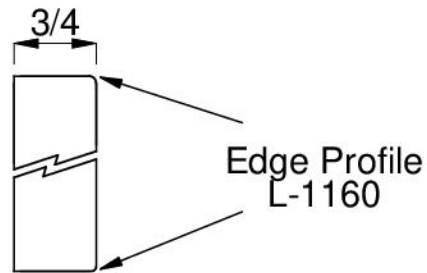

Small Drawer Front with reduced rails 'SDF'

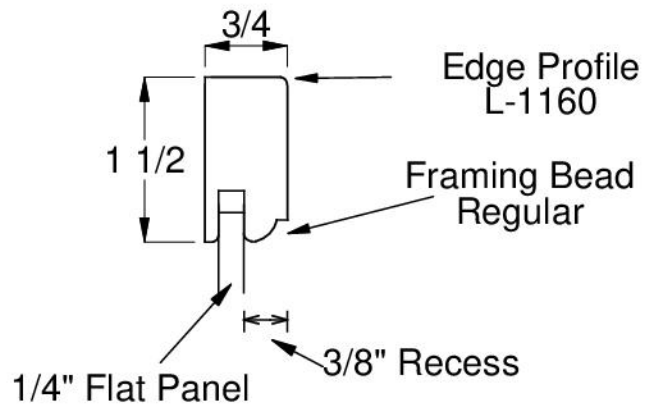
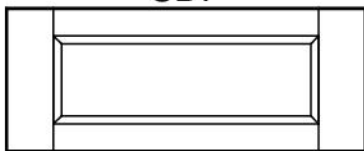

Large Drawer Front match door framing 'LDF'

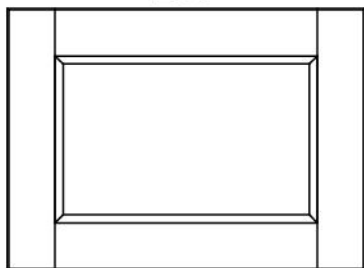

match door framing  
(see door detail above)



## Quaker Level 1

Framed	Frameless	Plywood	Furniture Board	Plain Inset	Beaded Inset	Full Overlay	Matching Drawer Front	Radius Door	Standard Hood Front	Concealed Hinge	Standard R.P. Arched Valance	Available Painted	Wainscot

Notes:

Actual framing size may vary between 2-1/4" and 2-5/16" depending on vendor selected by Wellsford.

Minimum Size: 7"w x 5"h

Section Drawings of options available:

MDF Availability		
1 PC	2 PC	5 PC

## Level 1

Quaker

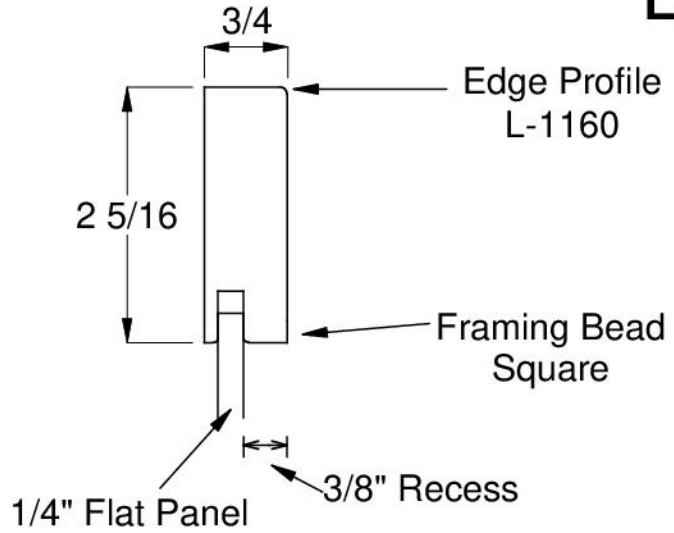
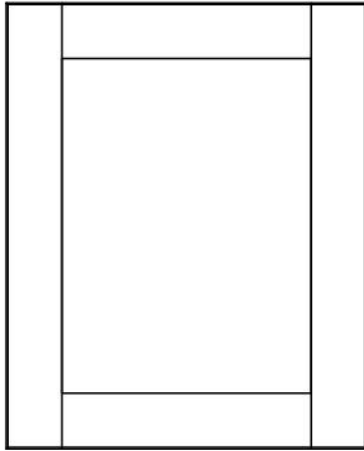

Slab

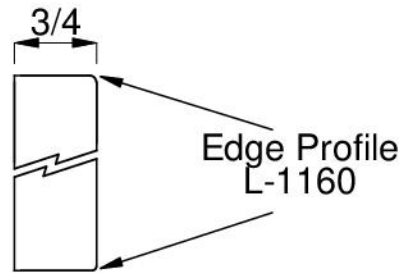

Small Drawer Front with reduced rails 'SDF'

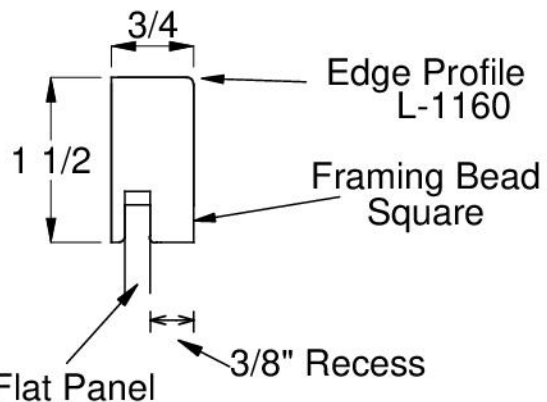
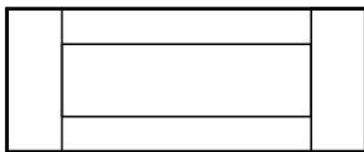

Large Drawer Front match door framing 'LDF'

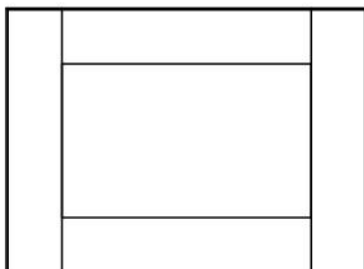

match door framing  
(see door detail above)



## Savoy Level 1

Framed	Frameless	Plywood	Furniture Board	Plain Inset	Beaded Inset	Full Overlay	Matching Drawer Front	Radius Door	Standard Hood Front	Concealed Hinge	Standard R.P. Arched Valance	Available Painted	Wainscot
NA				NA	NA			NA	NA		NA	NA	NA

**Notes:**

Specify horizontal or vertical grain.  
 Sequential grain match available –  
 max: 48" short grain, 96" long grain.  
 Order hardwood parts with machine edge to match profile.  
 Available wood species: bamboo, cherry, hard maple,  
 rift cut white oak, walnut.  
 Mullions not available in veneered doors. Suggest 1-lite (frame only)  
 glass door in Amesbury, Bristol or Quaker.  
 Mullion doors in Quaker only.

Minimum Size: 2-1/2"w x 6"h (max 48" x 96")

Section Drawings of options available:

MDF Availability		
1 PC	2 PC	5 PC
NA	NA	NA

## Level 1

### Savoy

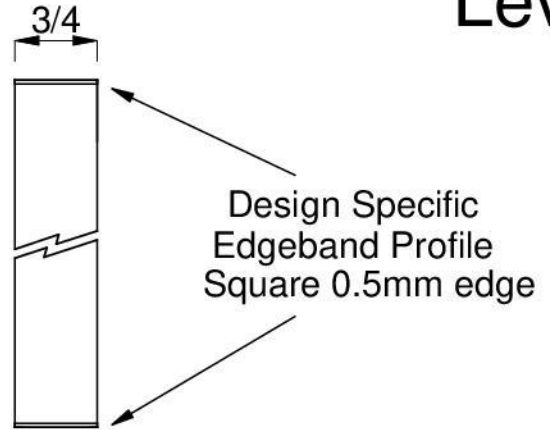
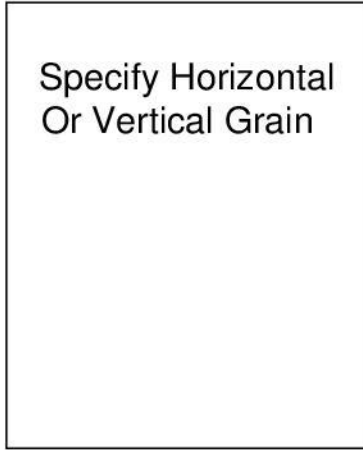

### Slab

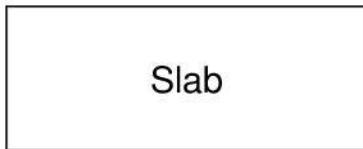

Specify Horizontal  
Or Vertical Grain

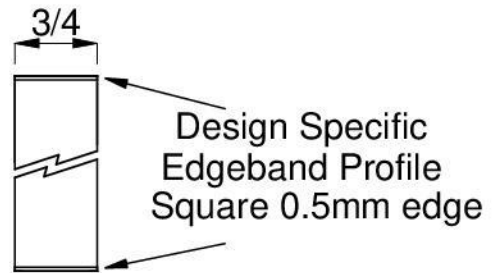



## Square Flat Level 1

Framed	Frameless	Plywood	Furniture Board	Plain Inset	Beaded Inset	Full Overlay	Matching Drawer Front	Radius Door	Standard Hood Front	Concealed Hinge	Standard R.P. Arched Valance	Available Painted	Wainscot

Notes:

Your choice of available edge profiles (p.1.236) and framing beads (p.1.238-239).  
 Actual framing size may vary between 2-1/4" and 2-5/16" depending on vendor selected by Wellsford.

Minimum Size: 7"w x 5"h

Section Drawings of options available:

MDF Availability		
1 PC	2 PC	5 PC

## Level 1

### Square Flat

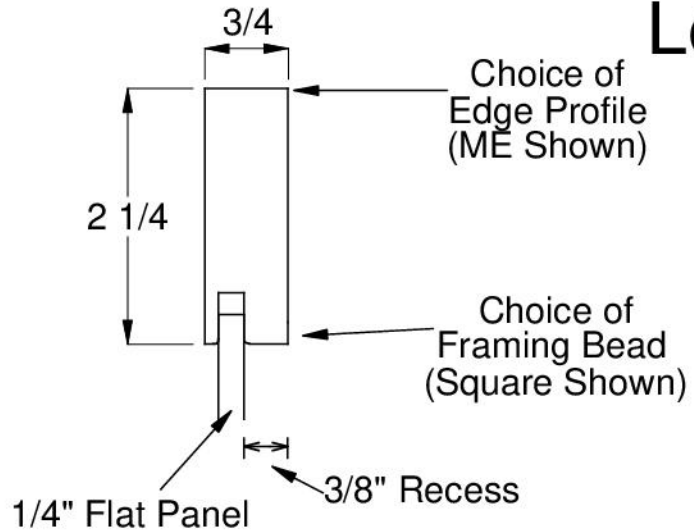
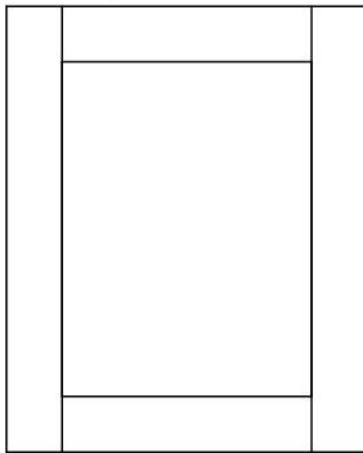

### Slab

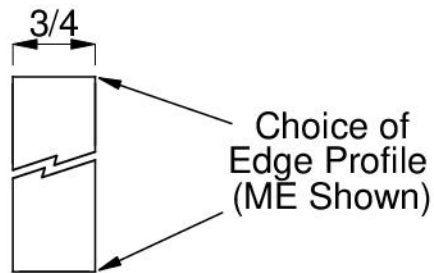
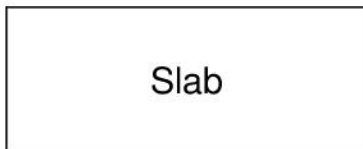

### Small Drawer Front with reduced rails 'SDF'

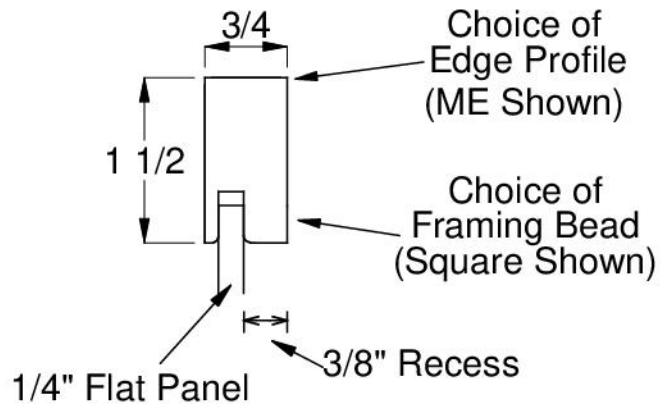
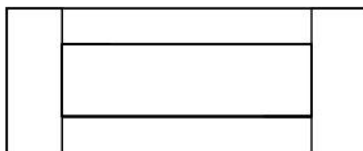

### Large Drawer Front match door framing 'LDF'

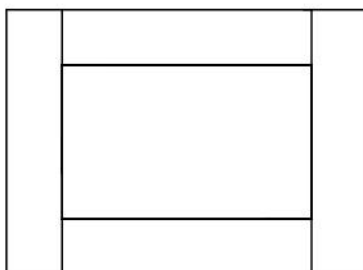

match door framing  
(see door detail above)



## NOTES





# LEVEL 2



## Alexandria Level 2

Framed	Frameless	Plywood	Furniture Board	Plain Inset	Beaded Inset	Full Overlay	Matching Drawer Front	Radius Door	Standard Hood Front	Concealed Hinge	Standard R.P. Arched Valance	Available Painted	Wainscot

Notes:

Actual framing size may vary between 2-1/4" and 2-5/16" depending on vendor selected by Wellsford.

Minimum Size: 7-1/2"w x 7-1/2"h

MDF Availability		
1 PC	2 PC	5 PC

Section Drawings of options available:

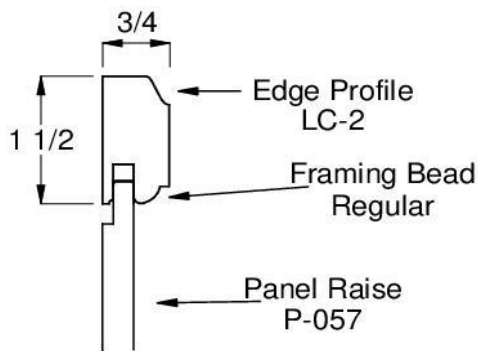

Drawer Panel Option

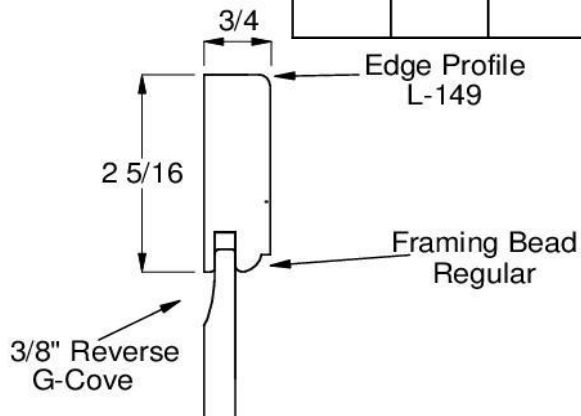

Door Panel and Edge Profile Option

Alexandria

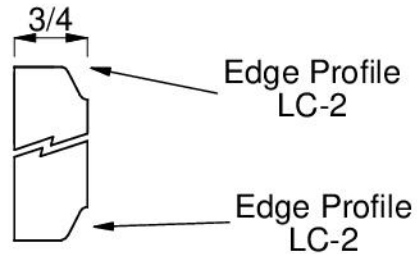
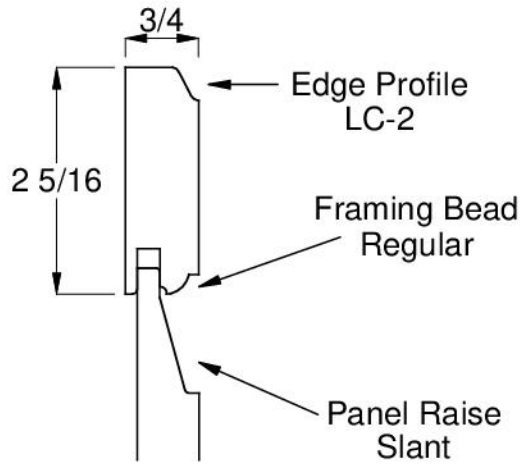
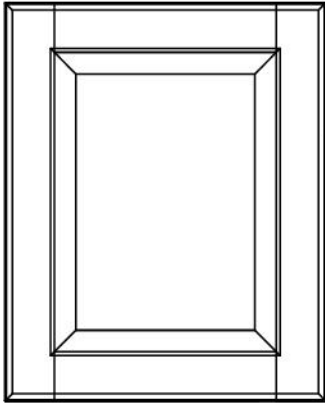

#10 Profiled Slab (1" Thick)

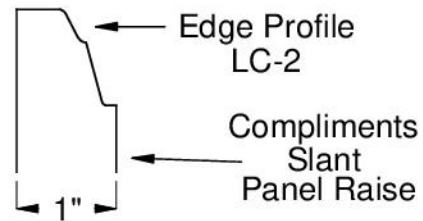
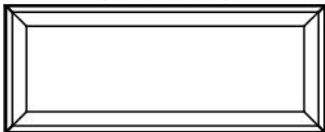

Small Drawer Front with reduced rails 'SDF'

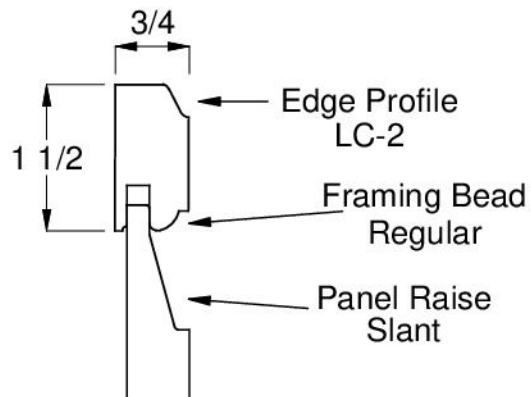
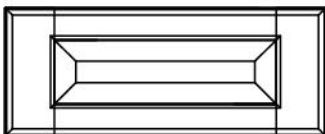

Large Drawer Front match door framing 'LDF'

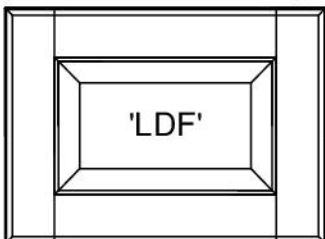

match door framing  
(see door detail above)



## Amesbury Level 2

Framed	Frameless	Plywood	Furniture Board	Plain Inset	Beaded Inset	Full Overlay	Matching Drawer Front	Radius Door	Standard Hood Front	Concealed Hinge	Standard R.P. Arched Valance	Available Painted	Wainscot
								NA		NA			

**Notes:**

Matching mullion bead not available –  
 Suggest square or regular bead  
 or 1-lite (frame only) glass door.  
 Glass recess will be 3/8" (ilo 1/8") on mullion doors.  
 1-lite (frame only) glass door available with 1/8" recess  
 on glass  
 Actual framing size may vary between 2-1/4" and 2-5/16"  
 depending on vendor selected by Wellsford.

Minimum Size: 7-1/2"w x 7-1/2"h

Section Drawings of options available:

MDF Availability		
1 PC	2 PC	5 PC
NA	NA	

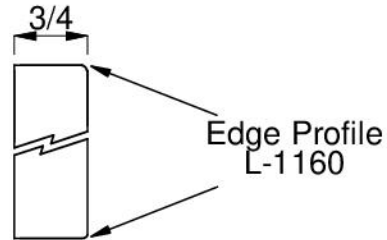
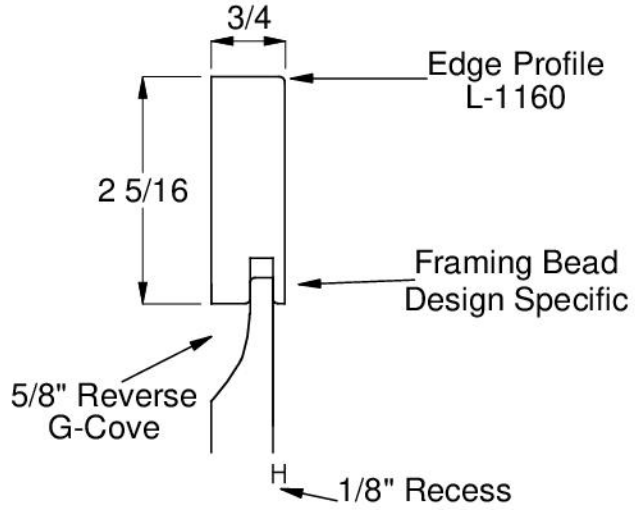
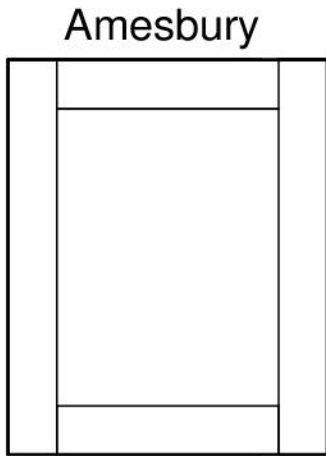

Small Drawer Front with reduced rails 'SDF'

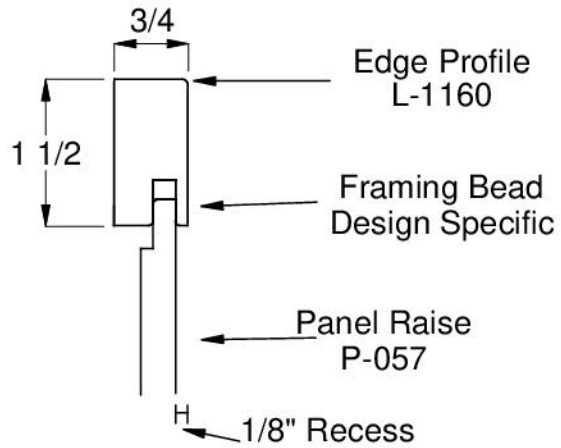
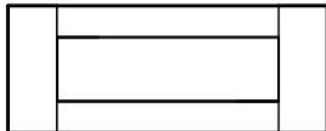

Large Drawer Front match door framing 'LDF'

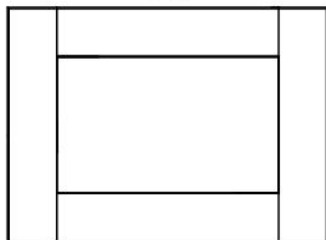

match door framing  
(see door detail above)



## Annapolis Level 2

Framed	Frameless	Plywood	Furniture Board	Plain Inset	Beaded Inset	Full Overlay	Matching Drawer Front	Radius Door	Standard Hood Front	Concealed Hinge	Standard R.P. Arched Valance	Available Painted	Wainscot

Notes:

Matching mullion bead not available –  
 Suggest regular or ogee mullion profile.  
 Actual framing size may vary between 2-1/4" and 2-5/16"  
 depending on vendor selected by Wellsford.

Minimum Size: 7-1/2"w x 7-1/2"h

MDF Availability		
1 PC	2 PC	5 PC

Section Drawings of options available:

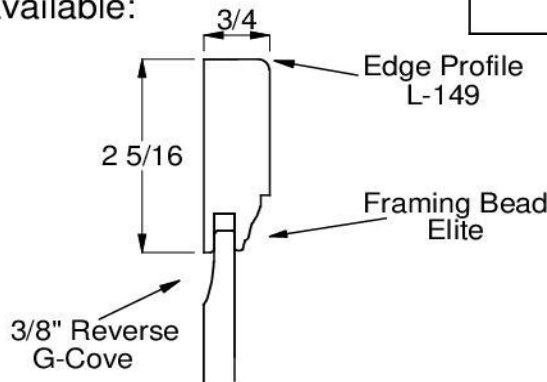
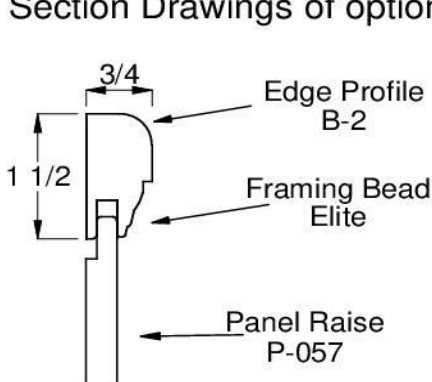

Drawer Panel Option

Door Panel and Edge Profile Option

Annapolis

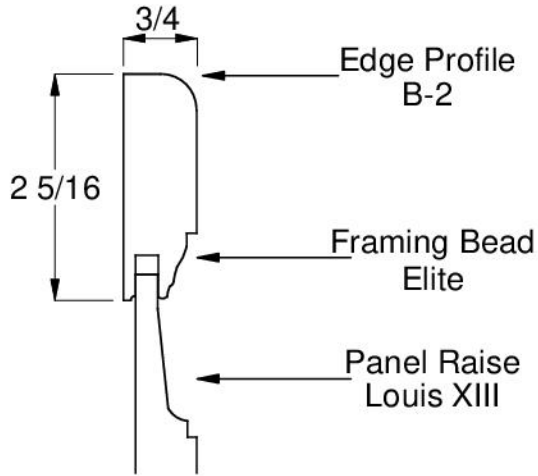
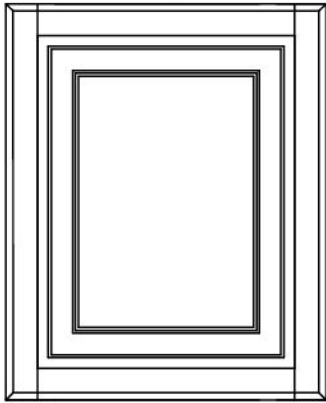

Slab

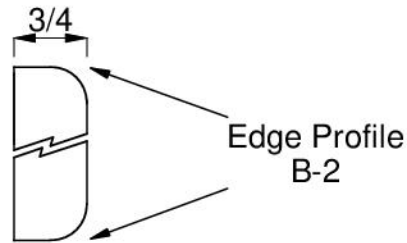

#10141  
(1" Thick slab)

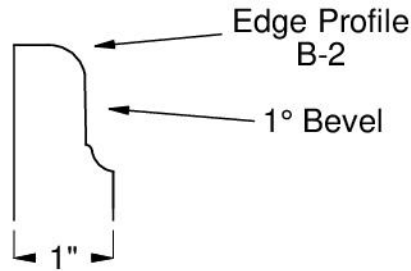
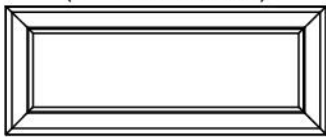

Small Drawer Front with  
reduced rails  
'SDF'

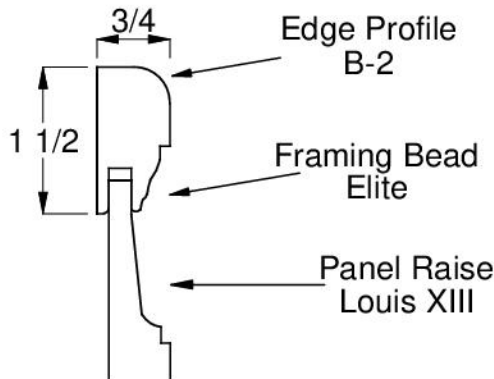

Large Drawer Front  
match door framing  
'LDF'

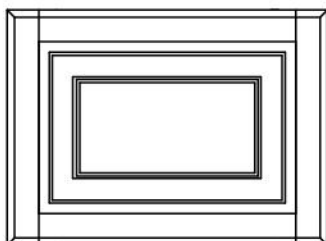

match door framing  
(see door detail above)

## Astor Level 2



Framed	Frameless	Plywood	Furniture Board	Plain Inset	Beaded Inset	Full Overlay	Matching Drawer Front	Radius Door	Standard Hood Front	Concealed Hinge	Standard R.P. Arched Valance	Available Painted	Wainscot
									NA		NA		

Notes:

1-1/2" rails on SDF available by custom quote.

Minimum Size: 9"w x 9"h

Section Drawings of options available:

MDF Availability		
1 PC	2 PC	5 PC
NA	NA	NA

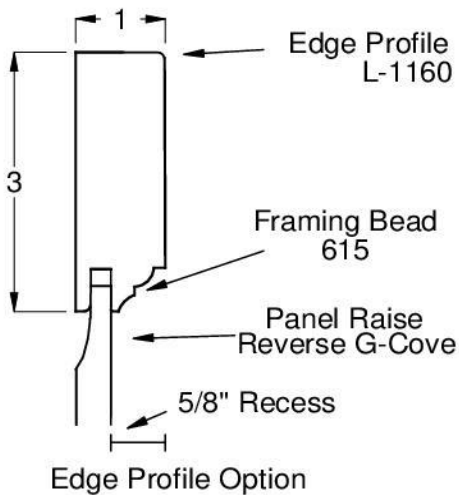



## Level 2

Astor

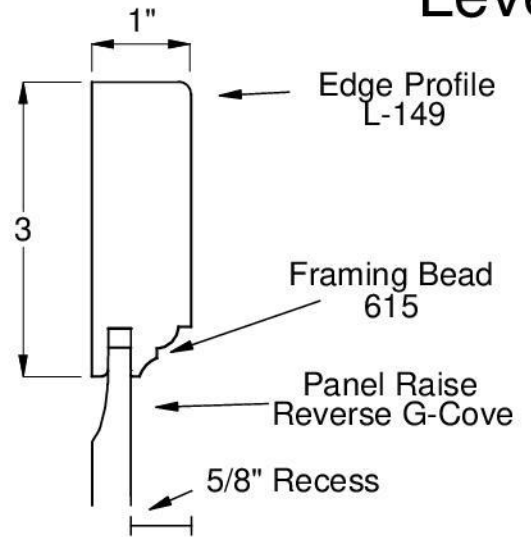
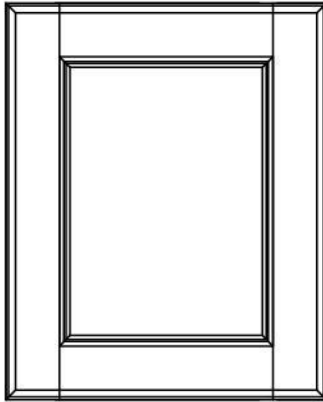

Slab

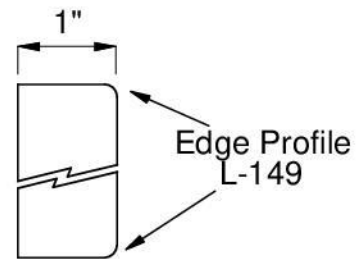
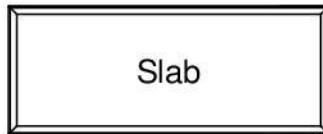

Small Drawer Front with reduced rails 'SDF'

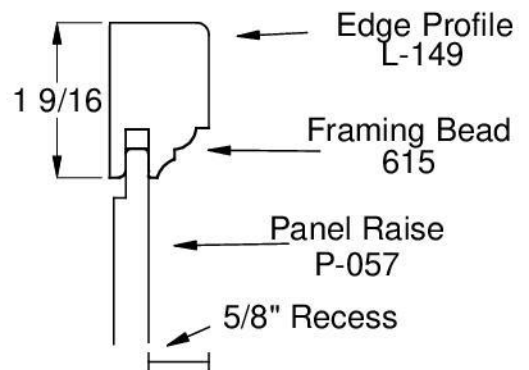

Large Drawer Front match door framing 'LDF'

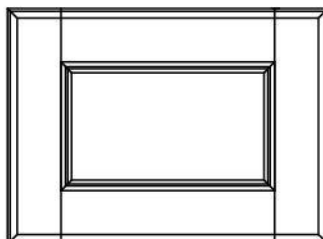

match door framing  
(see door detail above)



## Augusta Level 2

Framed	Frameless	Plywood	Furniture Board	Plain Inset	Beaded Inset	Full Overlay	Matching Drawer Front	Radius Door	Standard Hood Front	Concealed Hinge	Standard R.P. Arched Valance	Available Painted	Wainscot

Notes:

Actual framing size may vary between 2-1/4" and 2-5/16" depending on vendor selected by Wellsford.

Minimum Size: 7-1/2"w x 7-1/2"h

MDF Availability		
1 PC	2 PC	5 PC

Section Drawings of options available:

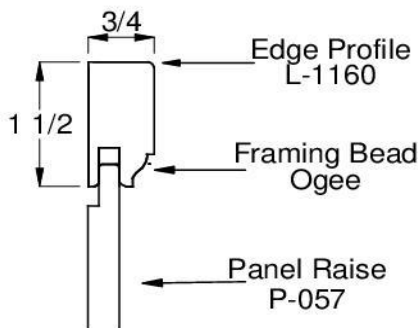

Drawer Panel and Edge Profile Options

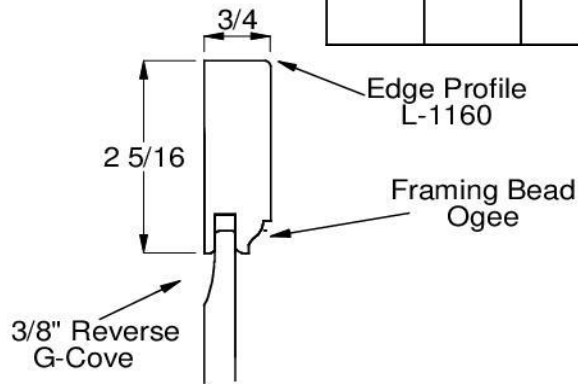

Door Panel and Edge Profile Option

## Level 2

Augusta

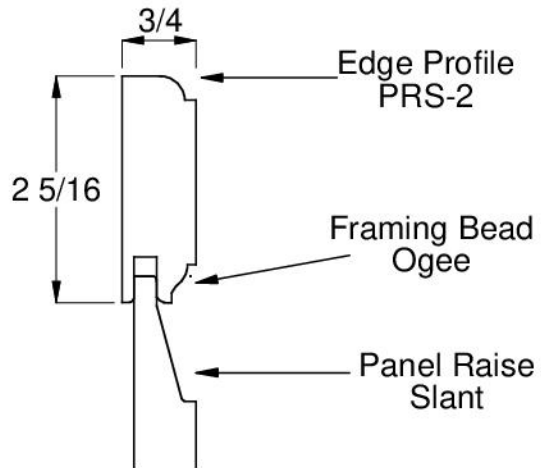
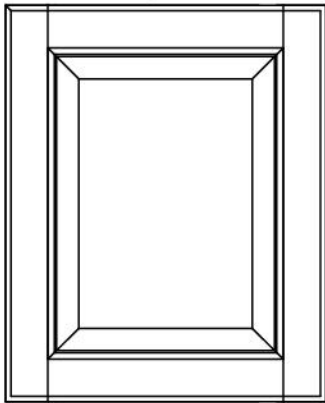

Slab

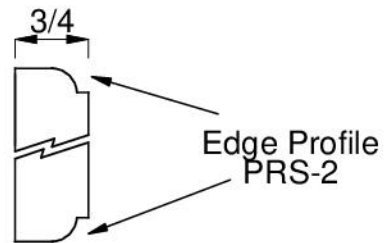
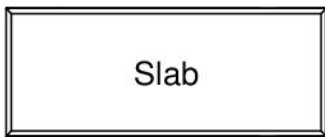

#10 Profiled Slab  
(1" Thick)

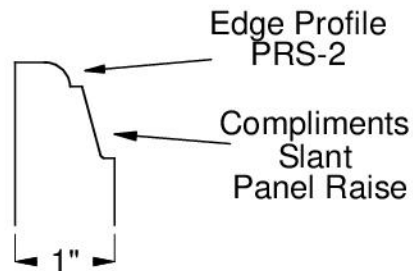
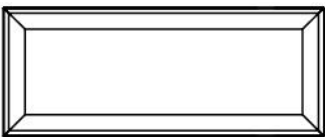

Small Drawer Front with  
reduced rails  
'SDF'

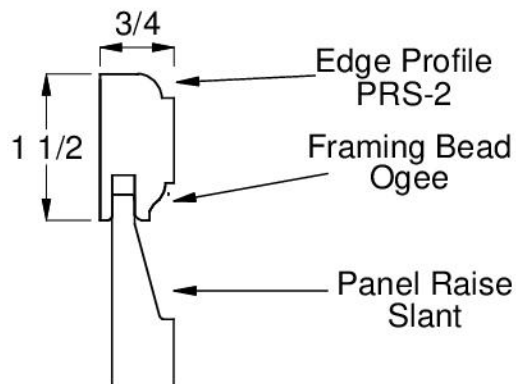
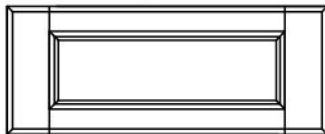

Large Drawer Front  
match door framing  
'LDF'

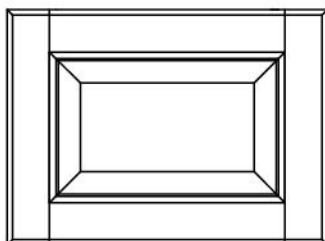

match door framing  
(see door detail above)



## Berkley Level 2

Framed	Frameless	Plywood	Furniture Board	Plain Inset	Beaded Inset	Full Overlay	Matching Drawer Front	Radius Door	Standard Hood Front	Concealed Hinge	Standard R.P. Arched Valance	Available Painted	Wainscot
									NA		NA		

Notes:

Matching mullion bead not available –  
Suggest square bead or 1-lite (frame only) glass door.

Minimum Size: 8-7/8" w x 7-1/2" h

Section Drawings of options available:

MDF Availability		
1 PC	2 PC	5 PC
		NA

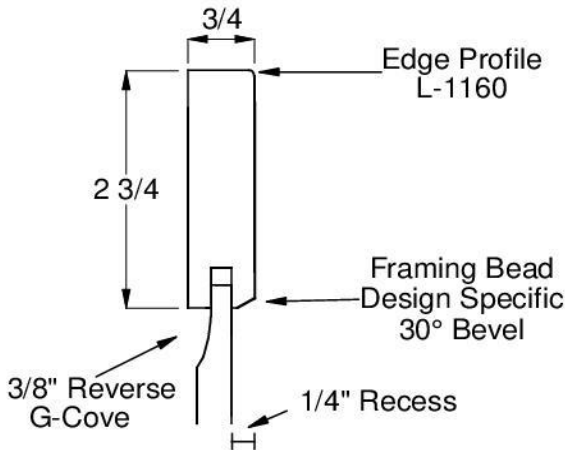

## Level 2

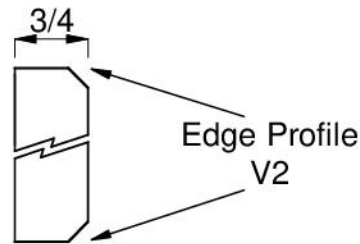
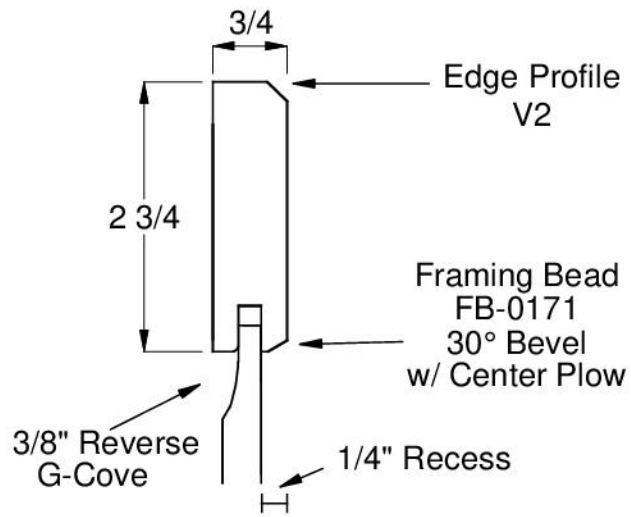
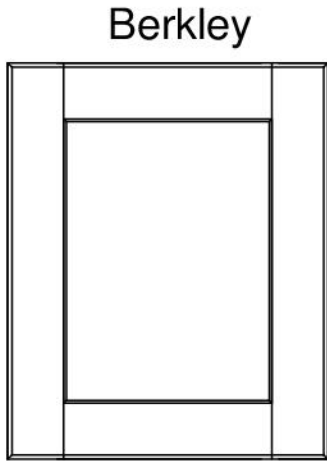

Small Drawer Front with reduced rails 'SDF'

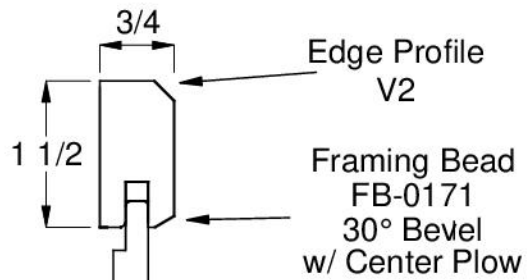
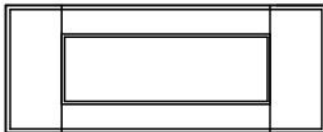

Large Drawer Front match door framing

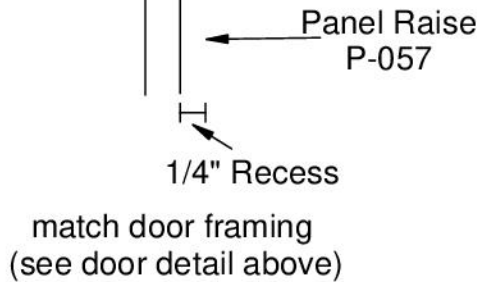
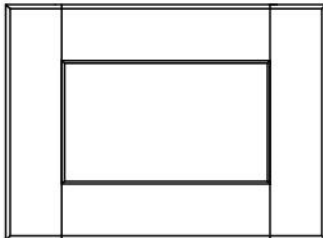



## Columbus Level 2

Framed	Frameless	Plywood	Furniture Board	Plain Inset	Beaded Inset	Full Overlay	Matching Drawer Front	Radius Door	Standard Hood Front	Concealed Hinge	Standard R.P. Arched Valance	Available Painted	Wainscot

Notes:

Actual framing size may vary between 2-1/4" and 2-5/16" depending on vendor selected by Wellsford.

Minimum Size: 7-1/2"w x 7-1/2"h

MDF Availability		
1 PC	2 PC	5 PC

Section Drawings of options available:

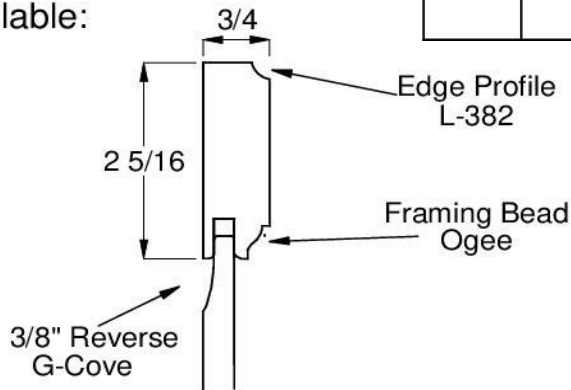
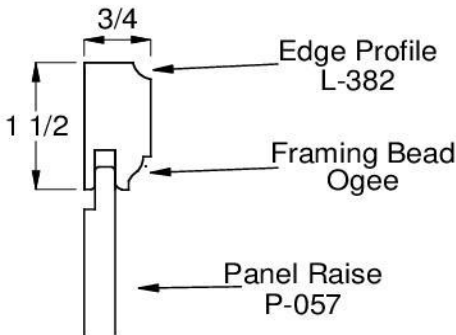

Drawer Panel Option

Door Panel Option

Columbus

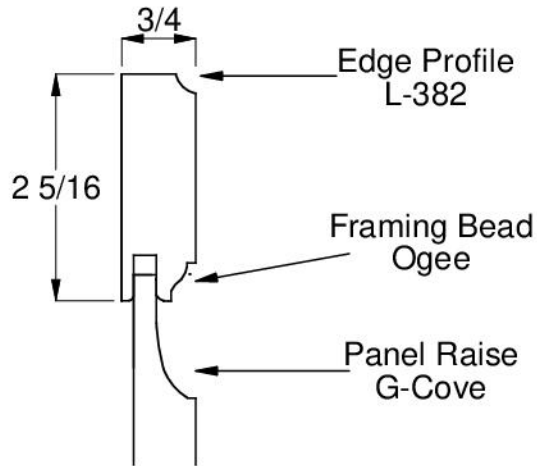
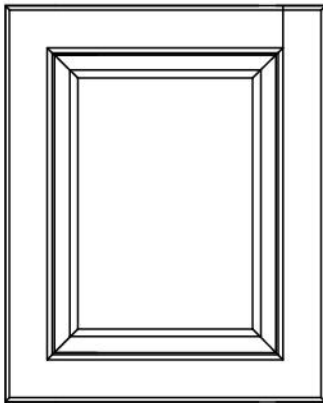

Slab

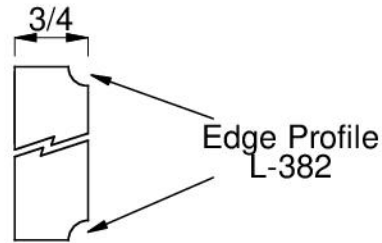

Keystone  
(1" Thick slab)

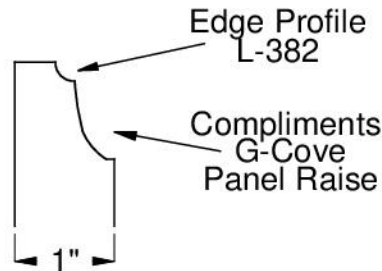
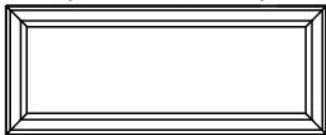

Small Drawer Front with  
reduced rails  
'SDF'

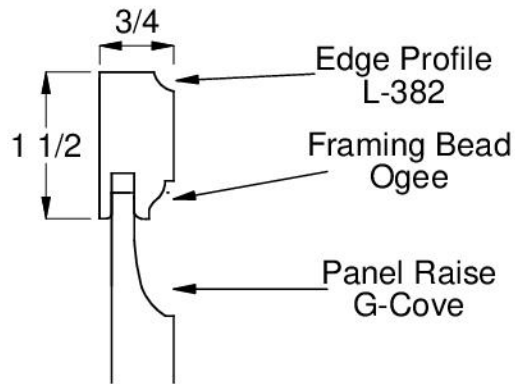
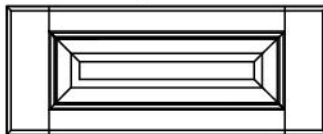

Large Drawer Front  
match door framing  
'LDF'

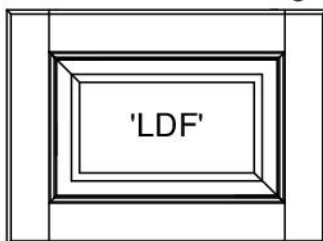

match door framing  
(see door detail above)



## Crest Level 2

Framed	Frameless	Plywood	Furniture Board	Plain Inset	Beaded Inset	Full Overlay	Matching Drawer Front	Radius Door	Standard Hood Front	Concealed Hinge	Standard R.P. Arched Valance	Available Painted	Wainscot

**Notes:**

Matching mullion bead not available –  
Suggest square bead or 1-lite (frame only) glass door.

Minimum Size: 8-7/8”w x 8-7/8”h

Section Drawings of options available:

MDF Availability		
1 PC	2 PC	5 PC
NA	NA	NA



## Level 2

Crest

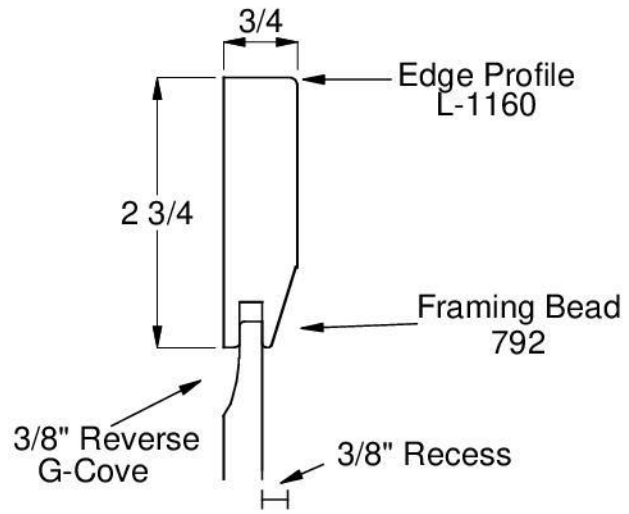
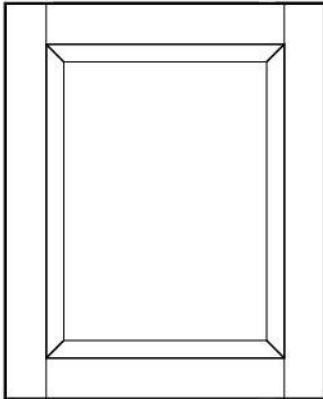

Slab

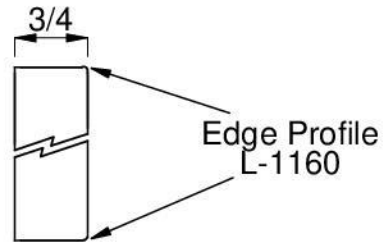

Small Drawer Front with reduced rails 'SDF'

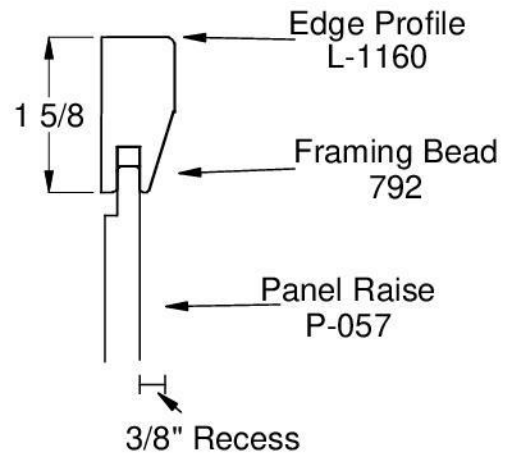
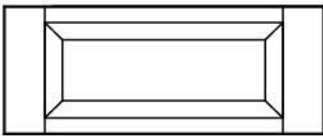

Large Drawer Front match door framing 'LDF'

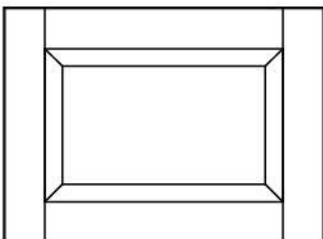

match door framing  
(see door detail above)

## Franklin Level 2



Framed	Frameless	Plywood	Furniture Board	Plain Inset	Beaded Inset	Full Overlay	Matching Drawer Front	Radius Door	Standard Hood Front	Concealed Hinge	Standard R.P. Arched Valance	Available Painted	Wainscot

Notes:

Minimum Size: 8-7/8" w x 8-7/8" h

Section Drawings of options available:

MDF Availability		
1 PC	2 PC	5 PC
NA	NA	

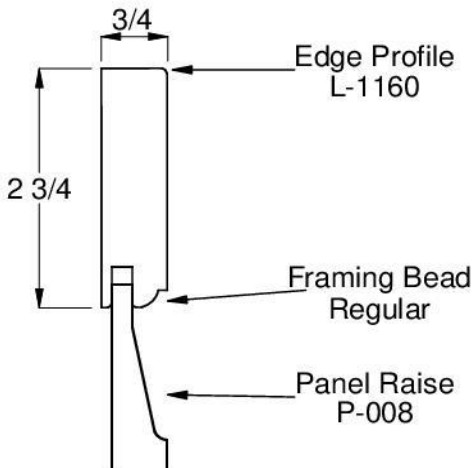

## Level 2

Franklin

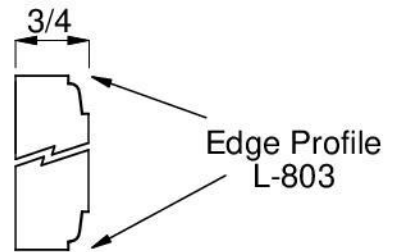
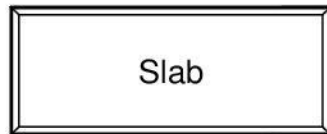
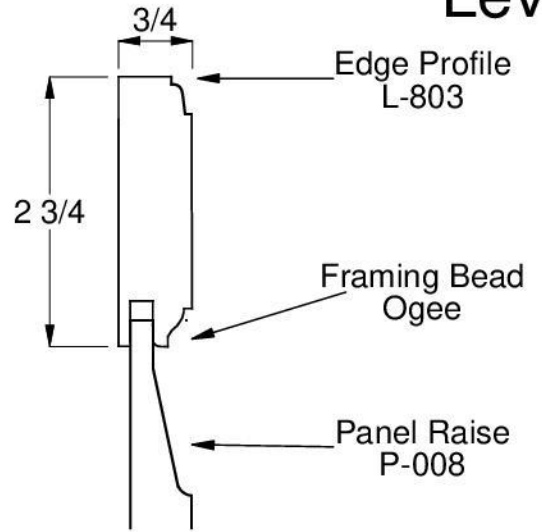
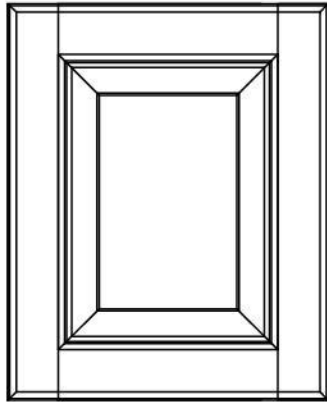

Small Drawer Front with reduced rails 'SDF'

Recommend Flat Panel (shown)

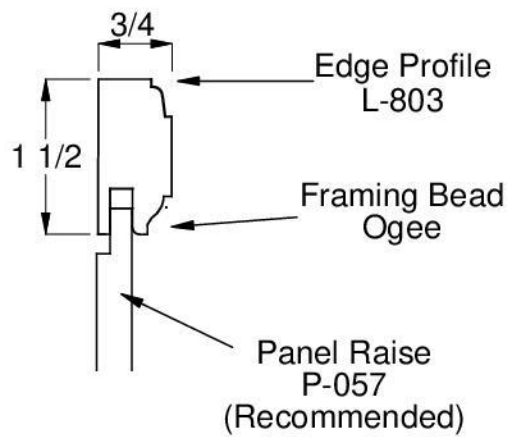
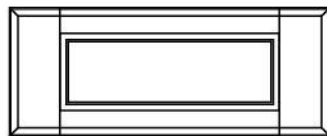

Large Drawer Front match door framing 'LDF'

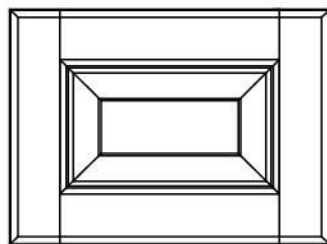

match door framing  
(see door detail above)



## Shaker Level 2

Framed	Frameless	Plywood	Furniture Board	Plain Inset	Beaded Inset	Full Overlay	Matching Drawer Front	Radius Door	Standard Hood Front	Concealed Hinge	Standard R.P. Arched Valance	Available Painted	Wainscot

Notes:

Minimum Size: 8-7/8" w x 8-7/8" h

Section Drawings of options available:

MDF Availability		
1 PC	2 PC	5 PC

## Level 2

Shaker

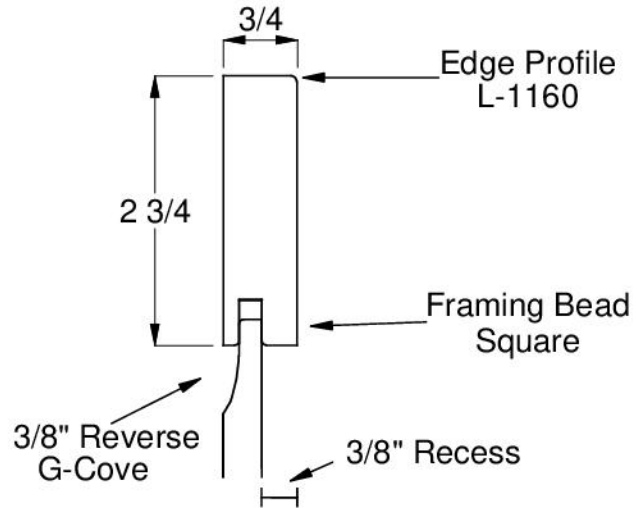
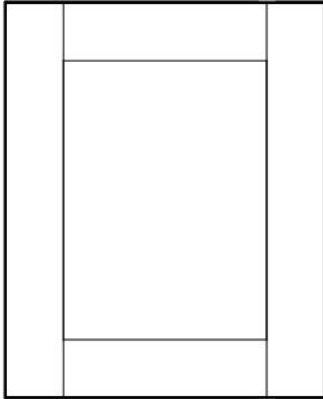

Slab

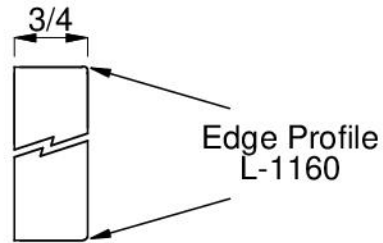

Small Drawer Front with reduced rails 'SDF'

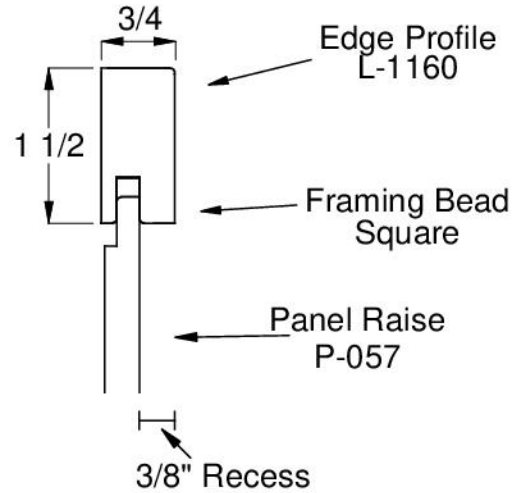
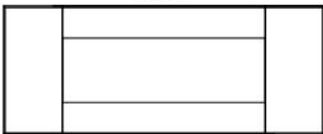

Large Drawer Front match door framing 'LDF'

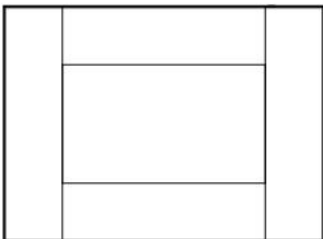

match door framing  
(see door detail above)



## Square Raised Level 2

Framed	Frameless	Plywood	Furniture Board	Plain Inset	Beaded Inset	Full Overlay	Matching Drawer Front	Radius Door	Standard Hood Front	Concealed Hinge	Standard R.P. Arched Valance	Available Painted	Wainscot

Notes:

Your choice of available edge profiles (p. 1.173), framing beads (p. 1.174-175). and panel raise (p. 1.176)  
 Actual framing size may vary between 2-1/4" and 2-5/16" depending on vendor selected by Wellsford.  
 \*Not all framing beads have matching mullion profiles.

Minimum Size: 7-1/2"w x 7-1/2"h

Section Drawings of options available:

MDF Availability		
1 PC	2 PC	5 PC

## Level 2

### Square Raised

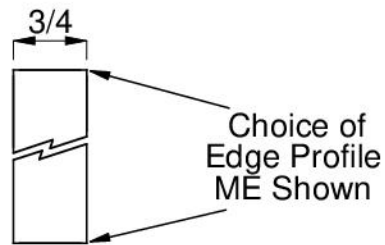
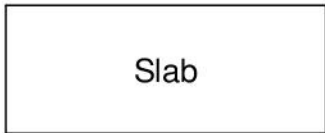
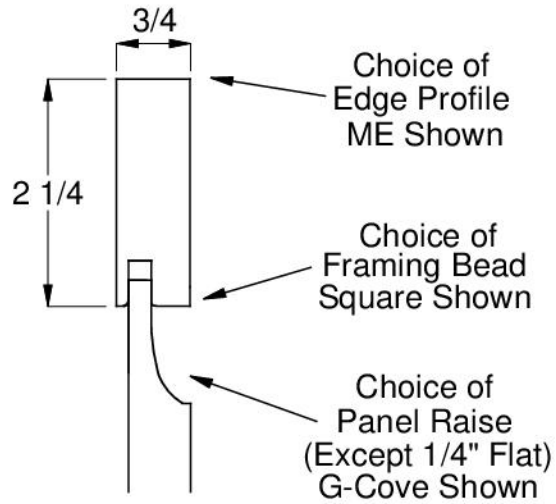
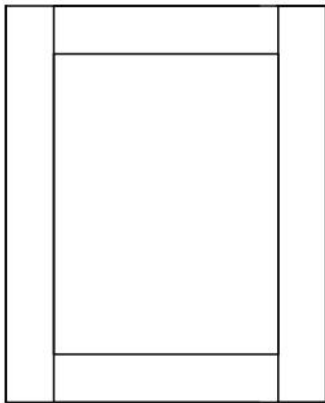

### Small Drawer Front with reduced rails 'SDF'

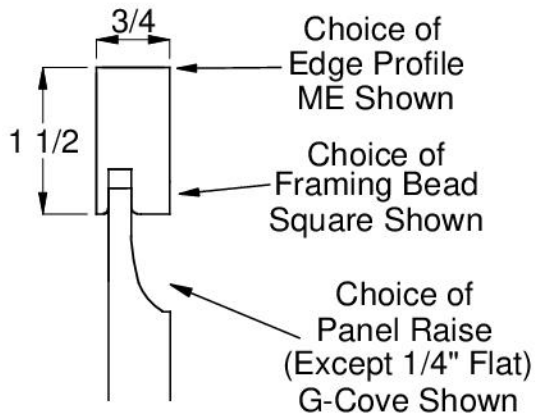
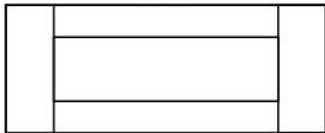

### Large Drawer Front match door framing 'LDF'

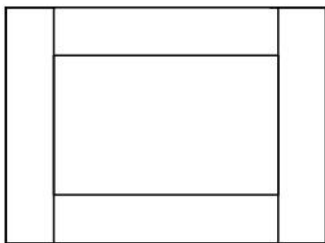

match door framing  
(see door detail above)



## Stockholm Level 2

Framed	Frameless	Plywood	Furniture Board	Plain Inset	Beaded Inset	Full Overlay	Matching Drawer Front	Radius Door	Standard Hood Front	Concealed Hinge	Standard R.P. Arched Valance	Available Painted	Wainscot

**Notes:**

Grain match is not available on solid wood doors.  
 If grain match is desired select a veneered door from Level 1.  
 MDF is preferred for painted finishes.  
 MDF doors do not have battens on the back.

Minimum Size: 6"w x 7-1/2"h

Section Drawings of options available:

MDF Availability		
1 PC	2 PC	5 PC
	NA	NA



## Level 2

### Stockholm

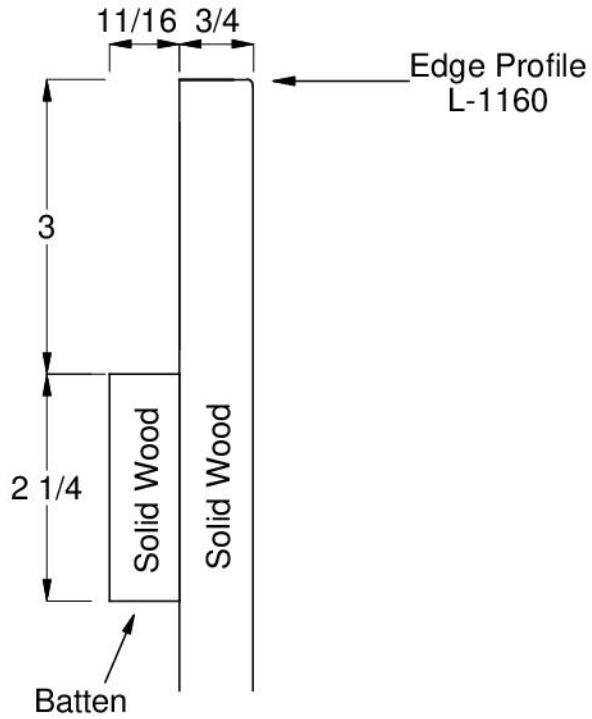
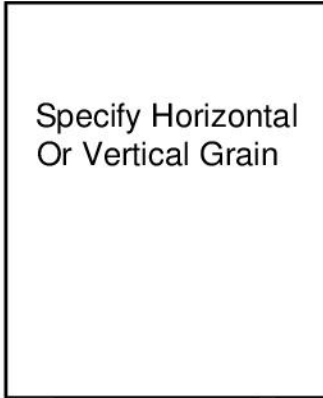

### 'SDF' + 'LDF'

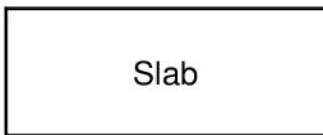

Specify Horizontal Or Vertical Grain

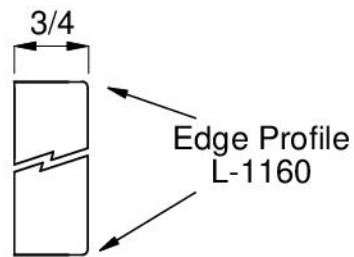

## Washington Level 2



Framed	Frameless	Plywood	Furniture Board	Plain Inset	Beaded Inset	Full Overlay	Matching Drawer Front	Radius Door	Standard Hood Front	Concealed Hinge	Standard R.P. Arched Valance	Available Painted	Wainscot

Notes:

Actual framing size may vary between 2-1/4" and 2-5/16" depending on vendor selected by Wellsford.

Minimum Size: 7-1/2"w x 7-1/2"h

MDF Availability		
1 PC	2 PC	5 PC

Section Drawings of options available:

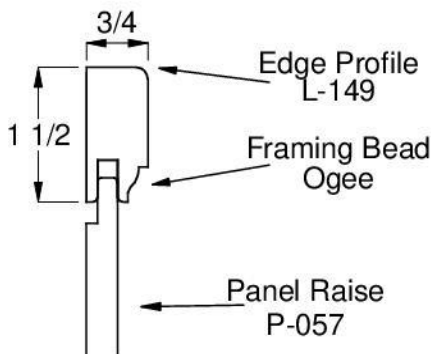

Drawer Panel Option

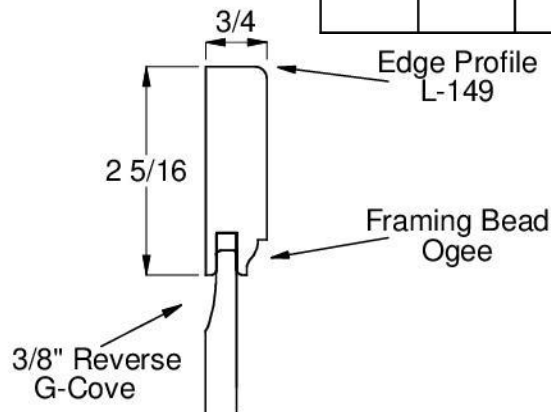

Door Panel Option

Washington

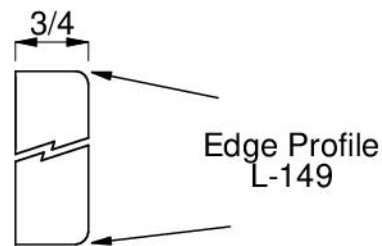
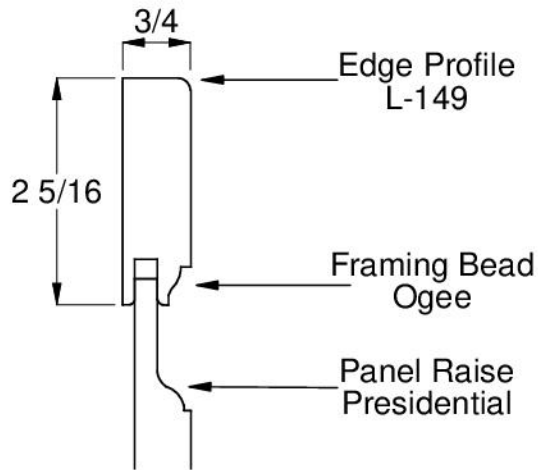
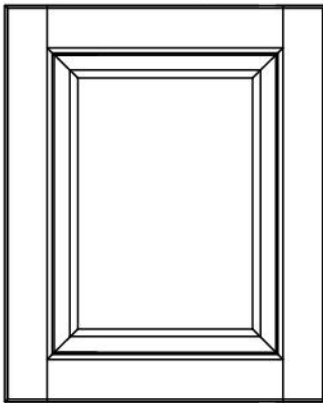

#10141  
(1" Thick slab)

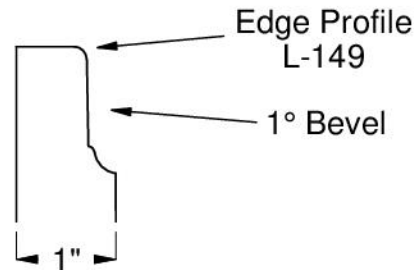
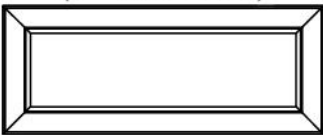

Small Drawer Front with  
reduced rails  
'SDF'

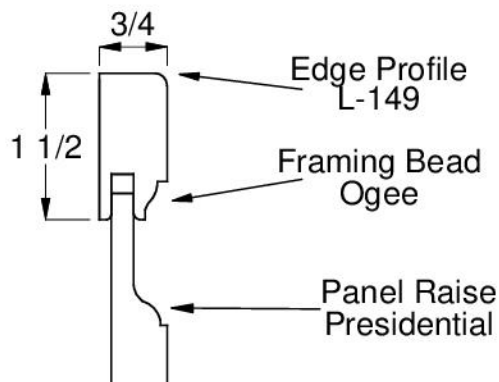
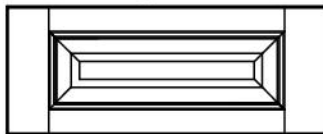

Large Drawer Front  
match door framing  
'LDF'

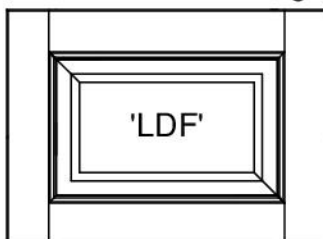

match door framing  
(see door detail above)



## Wright Level 2

Framed	Frameless	Plywood	Furniture Board	Plain Inset	Beaded Inset	Full Overlay	Matching Drawer Front	Radius Door	Standard Hood Front	Concealed Hinge	Standard R.P. Arched Valance	Available Painted	Wainscot
								NA		NA			

Notes:

Actual framing size may vary between 2-1/4" and 2-5/16" depending on vendor selected by Wellsford.

Minimum Size: 7-1/2"w x 7-1/2"h

MDF Availability		
1 PC	2 PC	5 PC
NA	NA	

Section Drawings of options available:

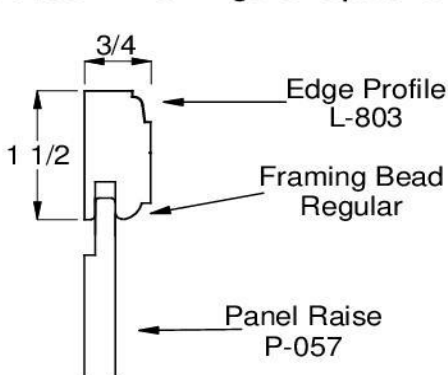

Drawer Panel Option

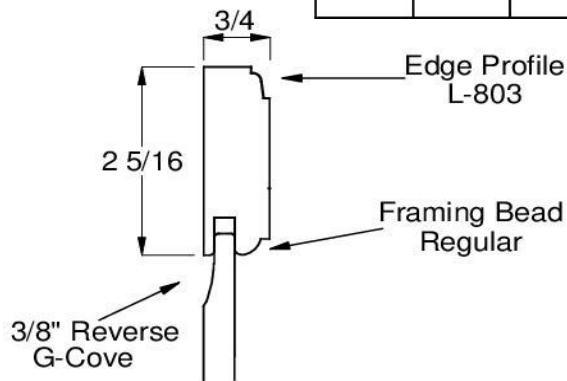

Door Panel Option

## Level 2

Wright

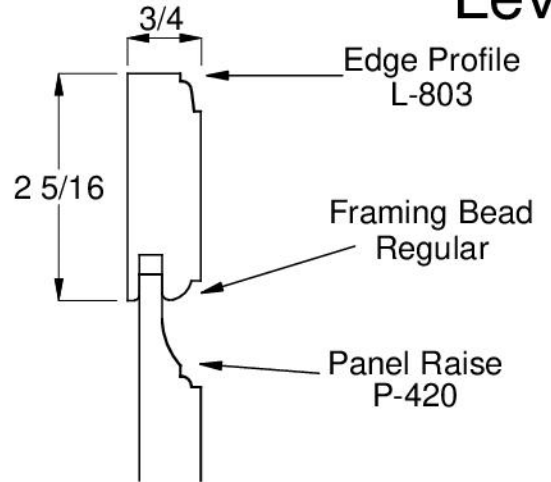
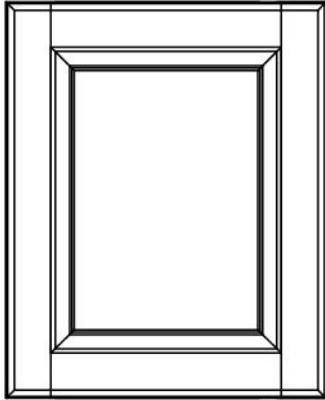

Slab

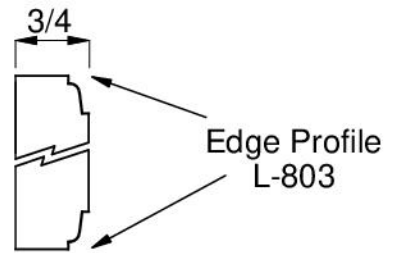

Small Drawer Front with reduced rails 'SDF'

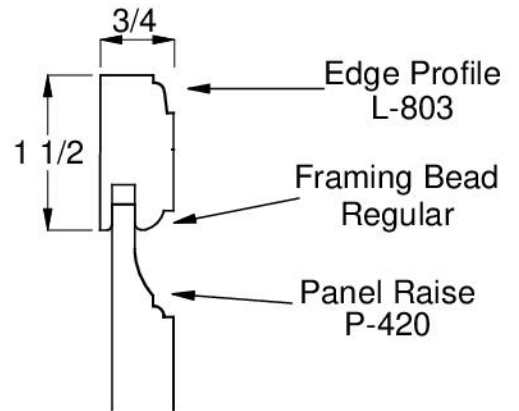

Large Drawer Front match door framing 'LDF'

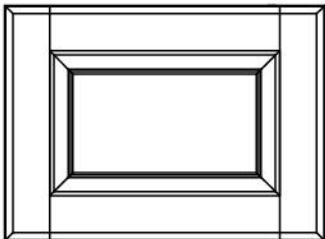

match door framing  
(see door detail above)



## NOTES



# LEVEL 3

## Brussels Level 3



Framed	Frameless	Plywood	Furniture Board	Plain Inset	Beaded Inset	Full Overlay	Matching Drawer Front	Radius Door	Standard Hood Front	Concealed Hinge	Standard R.P. Arched Valance	Available Painted	Wainscot
				NA	NA				NA		NA		NA

Notes:

Matching mullion bead not available –  
Suggest 1-lite (frame only) glass door.

Minimum Size: 7-1/2" w x 7-1/2" h

MDF Availability		
1 PC	2 PC	5 PC
NA	NA	NA

Section Drawings of options available:

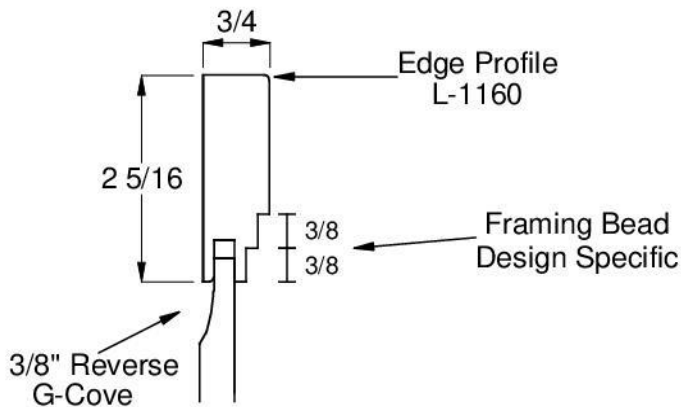

Door Edge Profile Option



## Level 3

Brussels

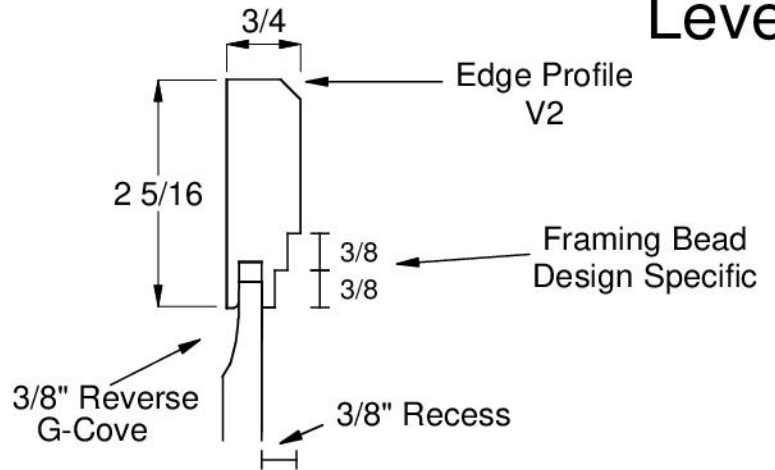
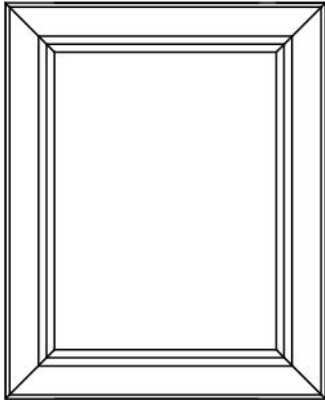

Slab

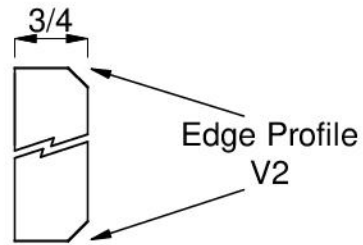
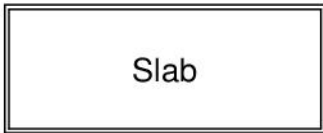

Small Drawer Front  
match door framing  
'SDF'

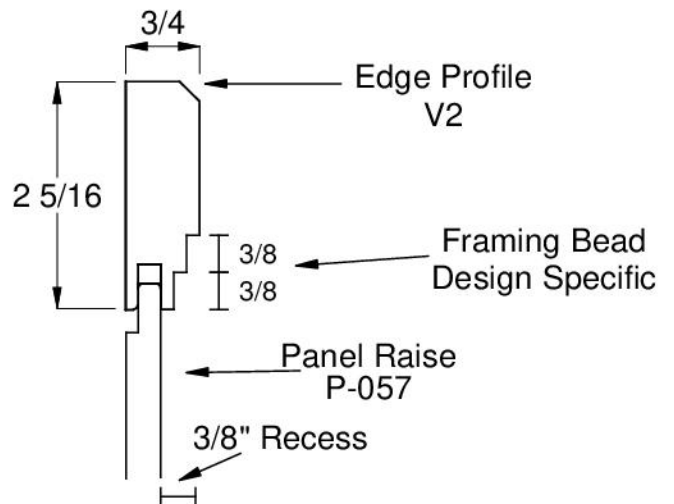
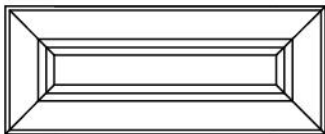

Large Drawer Front  
match door framing  
'LDF'

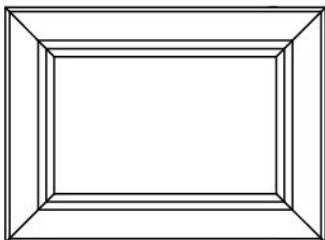

match small drawer front  
(see SDF detail above)



## Crawford Level 3

Framed	Frameless	Plywood	Furniture Board	Plain Inset	Beaded Inset	Full Overlay	Matching Drawer Front	Radius Door	Standard Hood Front	Concealed Hinge	Standard R.P. Arched Valance	Available Painted	Wainscot
								NA		NA			

**Notes:**

Matching mullion bead not available –  
Suggest 1-lite (frame only) glass door.

Minimum Size: 7-1/2"w x 7-1/2"h

Section Drawings of options available:

MDF Availability		
1 PC	2 PC	5 PC
		NA

## Level 3

Crawford

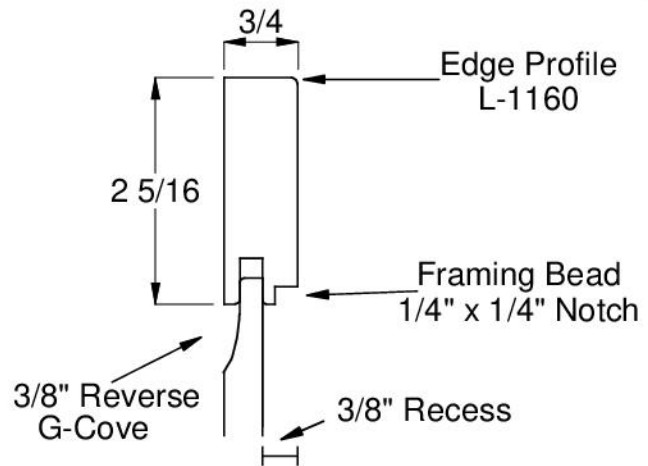
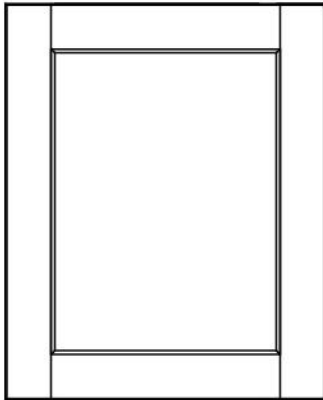

Slab

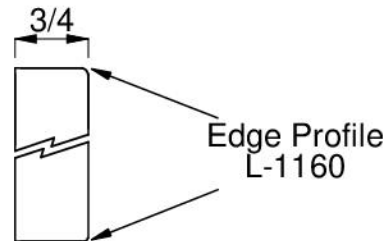

Small Drawer Front with reduced rails 'SDF'

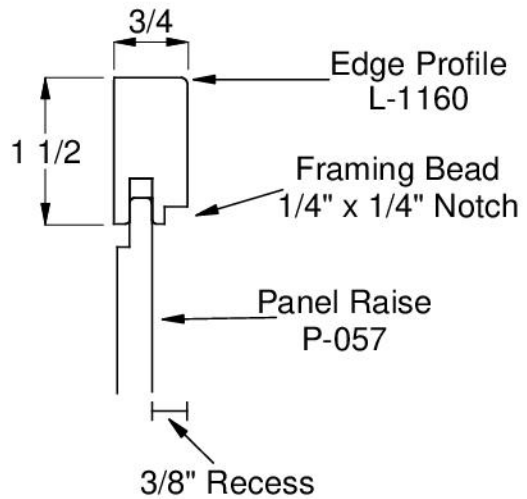
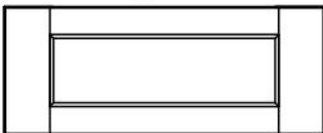

Large Drawer Front match door framing 'LDF'

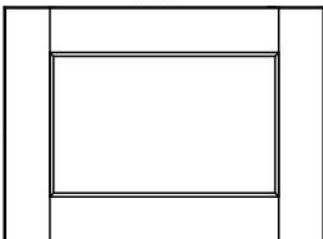

match door framing  
(see door detail above)



## Paris Level 3

Framed	Frameless	Plywood	Furniture Board	Plain Inset	Beaded Inset	Full Overlay	Matching Drawer Front	Radius Door	Standard Hood Front	Concealed Hinge	Standard R.P. Arched Valance	Available Painted	Wainscot
								NA		NA			

Notes:

Formerly the "French Inset" door style.  
 Actual framing size may vary between 2-1/4" and 2-5/16" depending on vendor selected by Wellsford.

Minimum Size: 7-1/2"w x 7-1/2"h

MDF Availability		
1 PC	2 PC	5 PC
		NA

Section Drawings of options available:

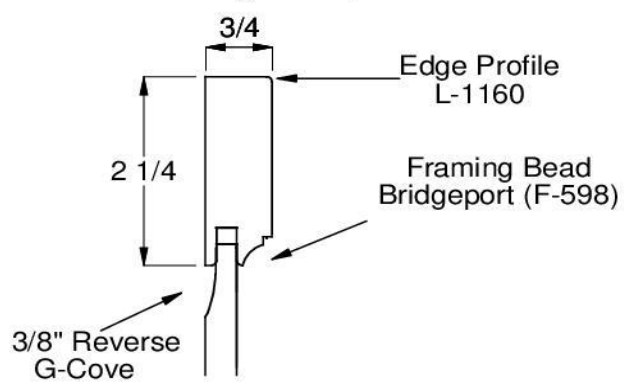

Door Panel Option

## Level 3

Paris

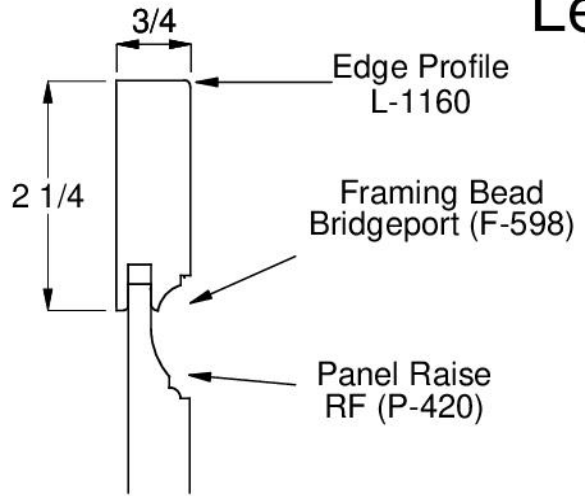
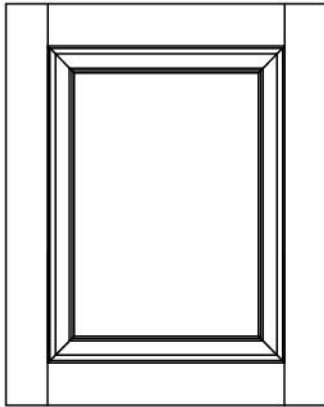

Slab

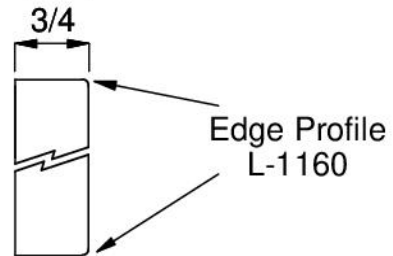
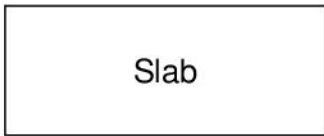

Small Drawer Front with reduced rails 'SDF'

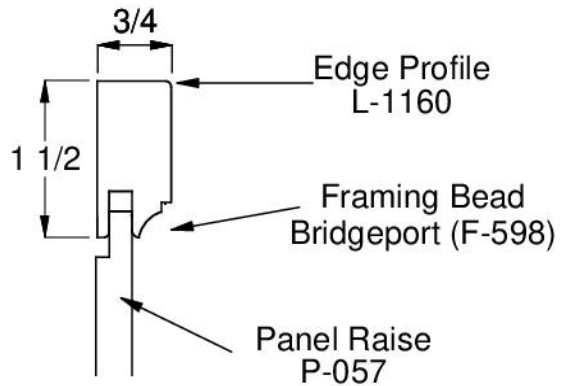
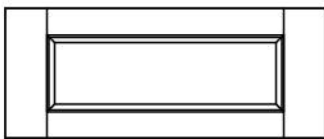

Large Drawer Front match door framing 'LDF'

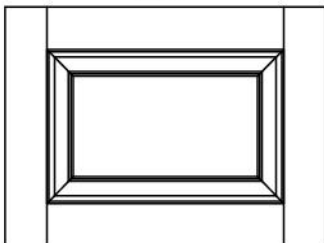

match door framing  
(see door detail above)



## Prestwick Level 3

Framed	Frameless	Plywood	Furniture Board	Plain Inset	Beaded Inset	Full Overlay	Matching Drawer Front	Radius Door	Standard Hood Front	Concealed Hinge	Standard R.P. Arched Valance	Available Painted	Wainscot

Notes:

Matching mullion bead not available –  
 Suggest square or regular bead  
 or 1-lite (frame only) glass door.  
 Glass recess will be 3/8" on mullion doors.  
 1-lite (frame only) glass door available with 1/8" recess  
 on glass.

Minimum Size: 7-1/2"w x 7-1/2"h

Section Drawings of options available:

MDF Availability		
1 PC	2 PC	5 PC
NA	NA	

## Level 3

Prestwick

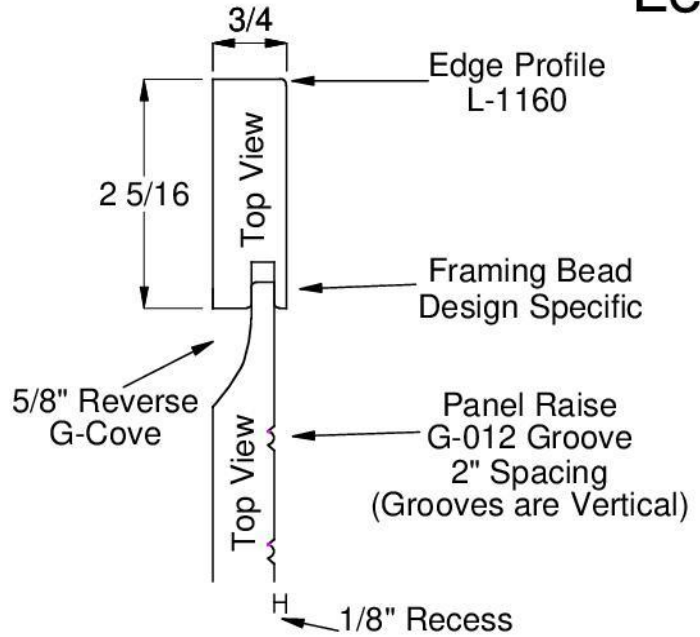
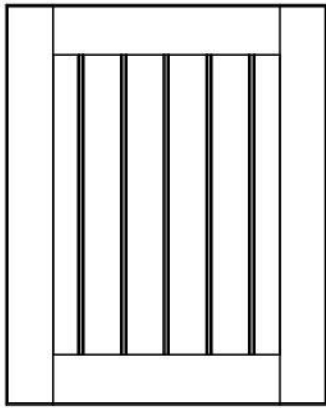

Slab

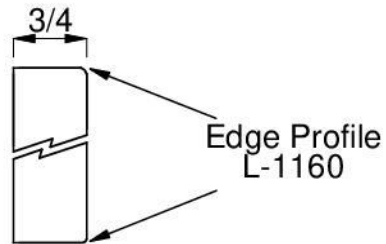

Small Drawer Front with reduced rails 'SDF'

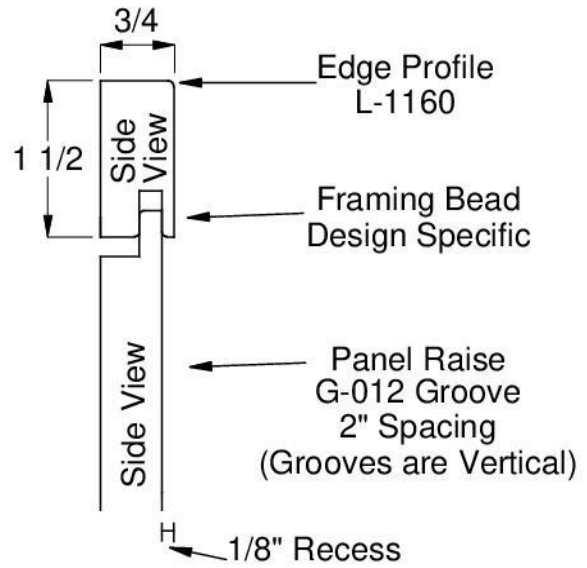
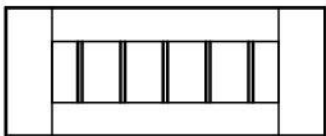

Large Drawer Front match door framing 'LDF'

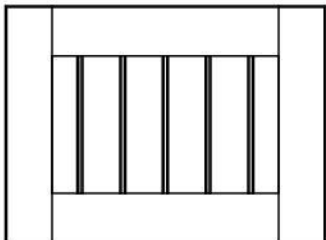

match door framing  
(see door detail above)



## Savannah Level 3

Framed	Frameless	Plywood	Furniture Board	Plain Inset	Beaded Inset	Full Overlay	Matching Drawer Front	Radius Door	Standard Hood Front	Concealed Hinge	Standard R.P. Arched Valance	Available Painted	Wainscot
				NA	NA				NA		NA		NA

**Notes:**

Matching mullion bead not available –  
Suggest square or regular mullion bead or 1-lite (frame only) glass door.

Minimum Size: 7-1/2"w x 7-1/2"h

MDF Availability		
1 PC	2 PC	5 PC
NA	NA	

Section Drawings of options available:

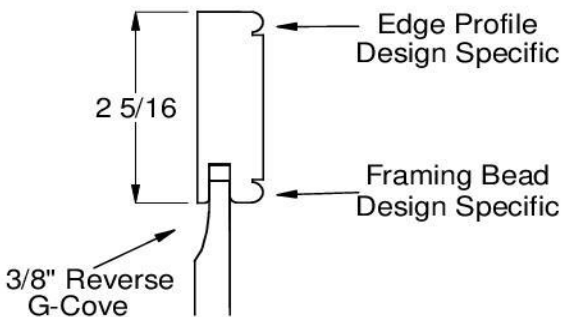

Door Panel Option

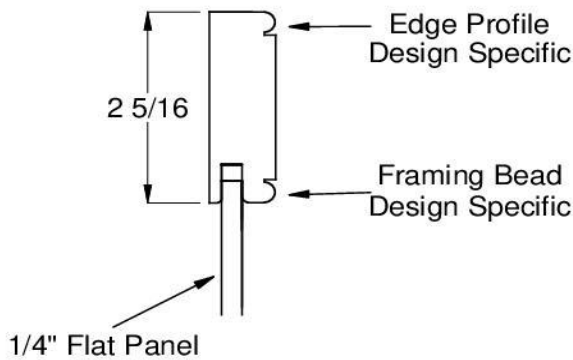

Door Panel Option



## Level 3

### Savannah

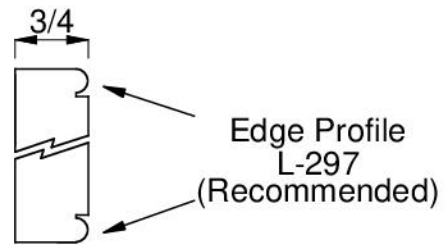
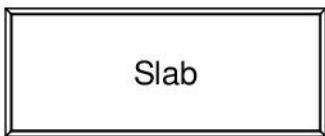
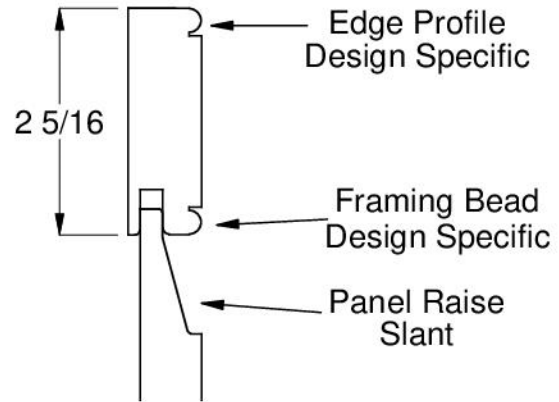
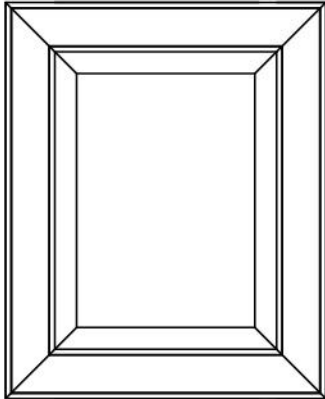

### 'SDF'

Recommend Flat Panel (shown)

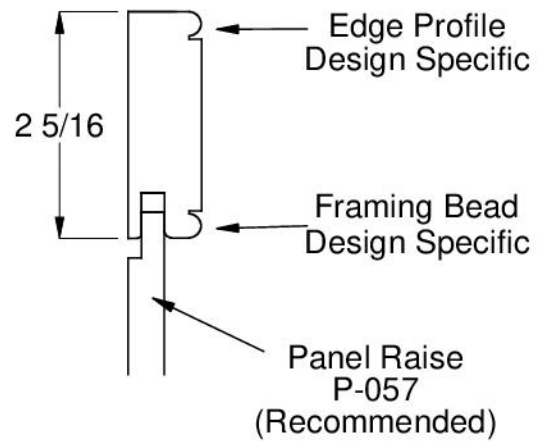
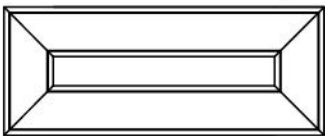

Large Drawer Front  
match door framing  
'LDF'

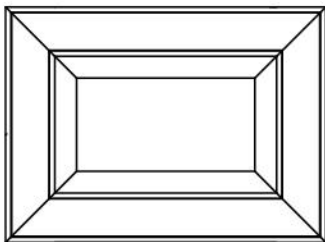

match door framing  
(see door detail above)



## Westminster Level 3

Framed	Frameless	Plywood	Furniture Board	Plain Inset	Beaded Inset	Full Overlay	Matching Drawer Front	Radius Door	Standard Hood Front	Concealed Hinge	Standard R.P. Arched Valance	Available Painted	Wainscot
								NA		NA			

**Notes:**

Matching mullion bead not available –  
Suggest 1-lite (frame only) glass door.

Minimum Size: 8" w x 8" h

Section Drawings of options available:

MDF Availability		
1 PC	2 PC	5 PC
NA	NA	NA

## Level 3

Westminster

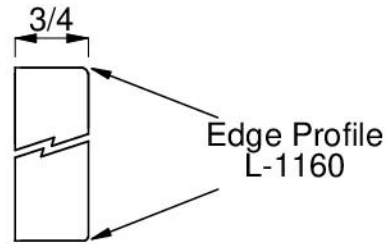
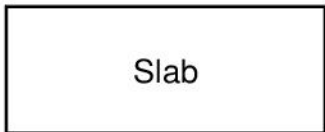
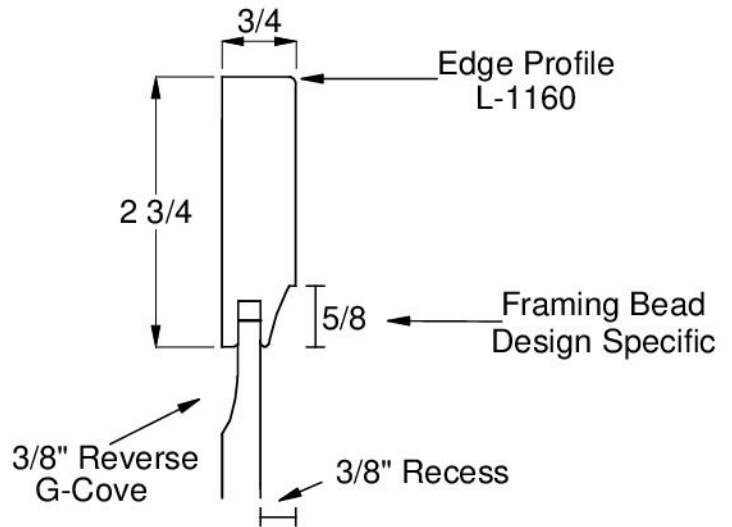
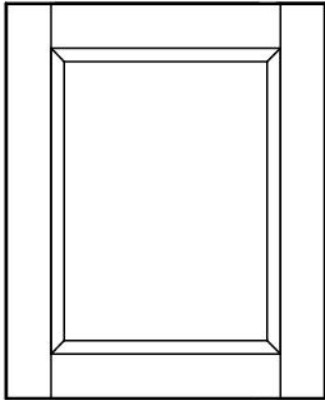

Small Drawer Front with reduced rails 'SDF'

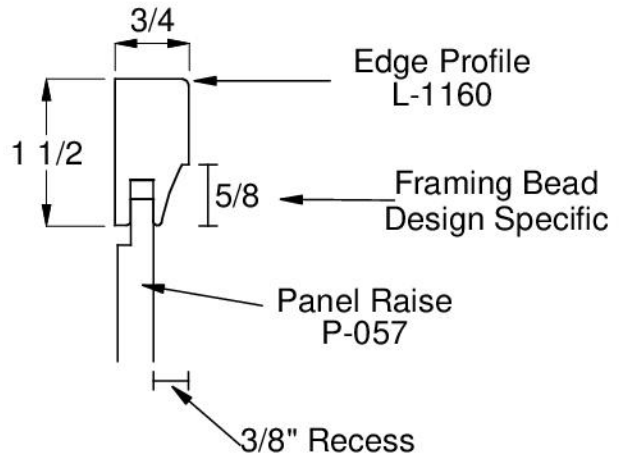
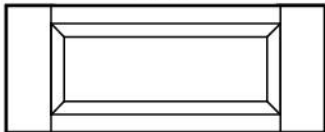

Large Drawer Front match door framing 'LDF'

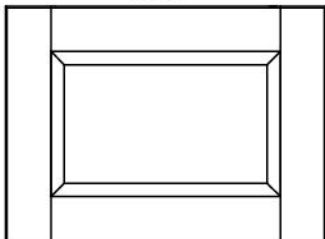

match door framing  
(see door detail above)



## NOTES



# LEVEL 4

## Austin Level 4



Framed	Frameless	Plywood	Furniture Board	Plain Inset	Beaded Inset	Full Overlay	Matching Drawer Front	Radius Door	Standard Hood Front	Concealed Hinge	Standard R.P. Arched Valance	Available Painted	Wainscot
									NA		NA		

**Notes:**

Not available in rustic knotty wood species  
 Actual framing size may vary between 2-1/4" and 2-5/16" depending on vendor selected by Wellsford.

Minimum Size: 7-1/2"w x 7-1/2"h

Section Drawings of options available:

MDF Availability		
1 PC	2 PC	5 PC
NA	NA	

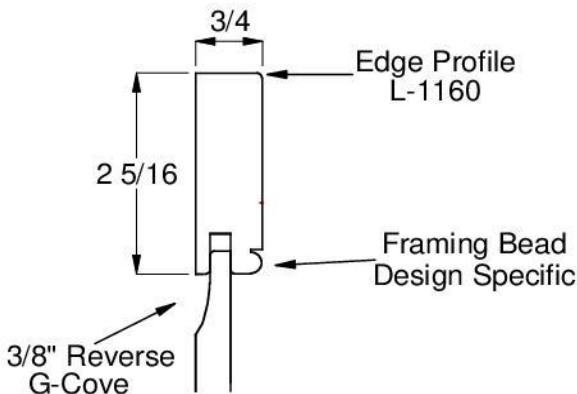

Edge Profile Option

## Level 4

Austin

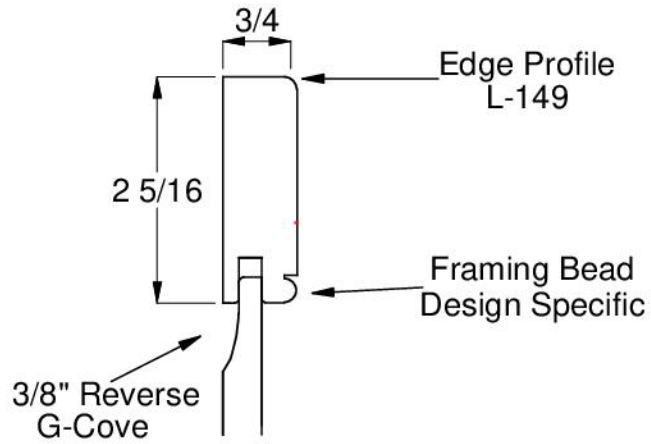
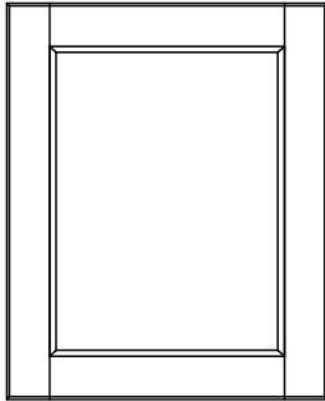

Slab

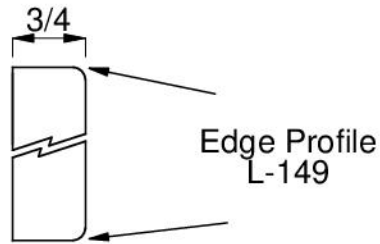

Small Drawer Front with Reduced Rails 'SDF'

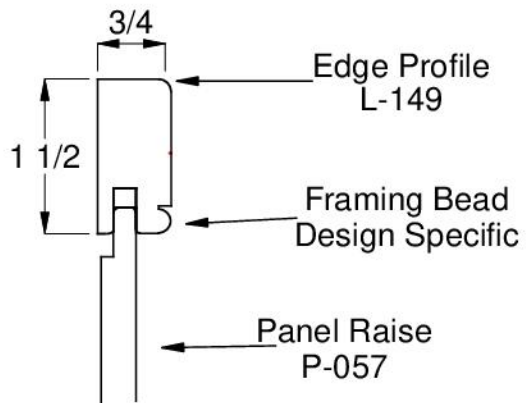
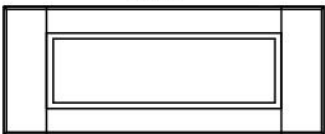

Large Drawer Front match door framing 'LDF'

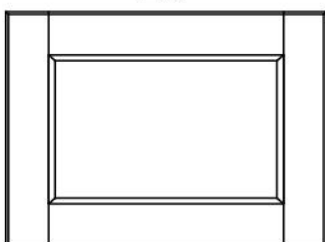

match door framing  
(see door detail above)



## Biltmore Level 4

Framed	Frameless	Plywood	Furniture Board	Plain Inset	Beaded Inset	Full Overlay	Matching Drawer Front	Radius Door	Standard Hood Front	Concealed Hinge	Standard R.P. Arched Valance	Available Painted	Wainscot
								NA		NA			

**Notes:**

Not available in bamboo wood.  
 Matching SDF not available in inset styles.  
 1-1/2" rails on SDF available by custom quote.

Minimum Size: 9-3/4"w x 9-3/4"h,  
 matching SDF 6" high

Section Drawings of options available:

MDF Availability		
1 PC	2 PC	5 PC
NA	NA	NA

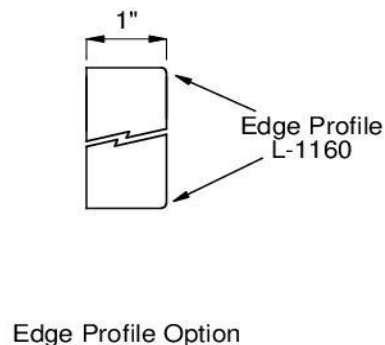
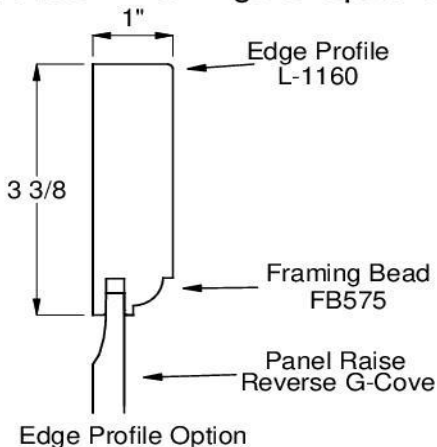



## Level 4

Biltmore

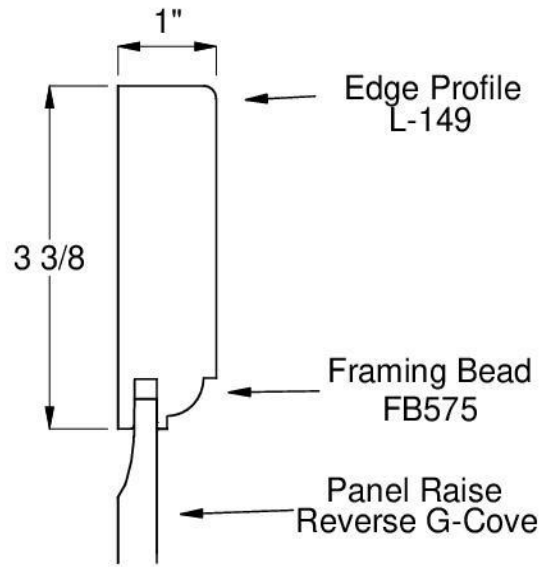
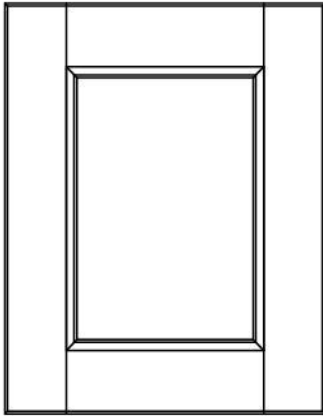

Slab

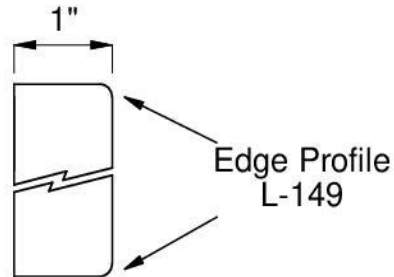

Small Drawer Front with  
2 1/4" rails  
'SDF'

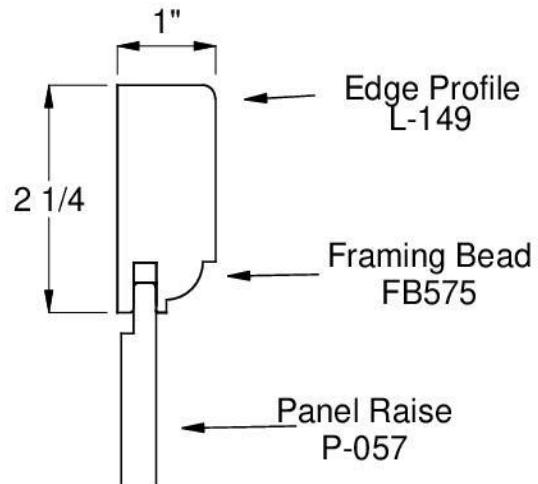
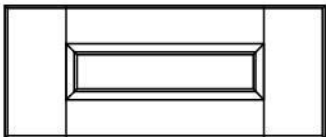

Large Drawer Front  
match door framing  
'LDF'

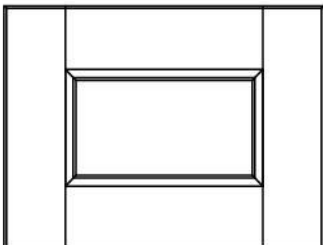

match door framing  
(see door detail above)



## Copenhagen Level 4

Framed	Frameless	Plywood	Furniture Board	Plain Inset	Beaded Inset	Full Overlay	Matching Drawer Front	Radius Door	Standard Hood Front	Concealed Hinge	Standard R.P. Arched Valance	Available Painted	Wainscot
				NA	NA			NA		NA			NA

**Notes:**

Not available in bamboo or rustic knotty species.

MDF version is 1" thick at its widest point.

Minimum Size: 7-1/8"w x 7-1/8"h

MDF Availability		
1 PC	2 PC	5 PC
		NA

Section Drawings of options available:

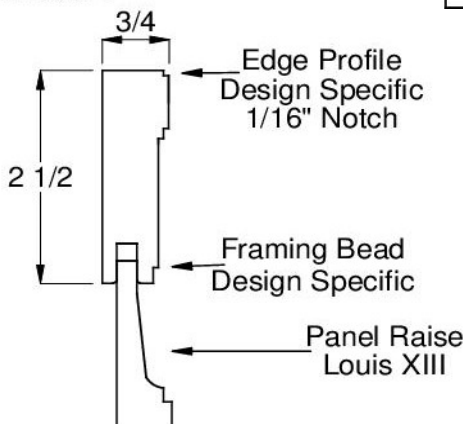
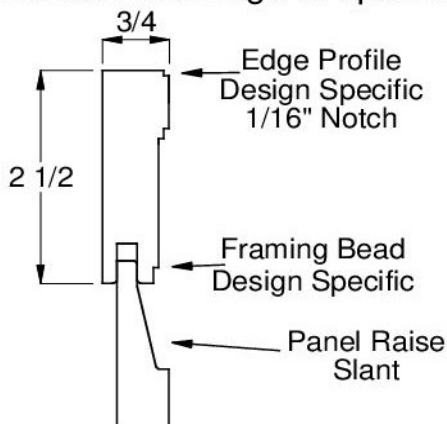

Door Panel Option

Door Panel Option

Copenhagen

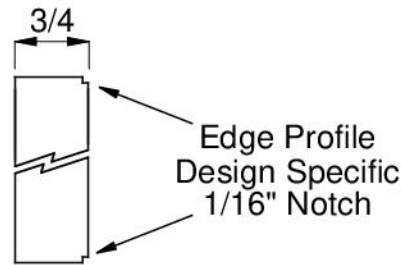
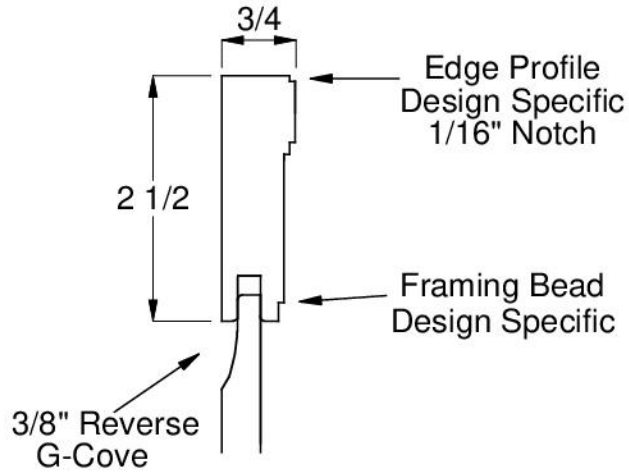
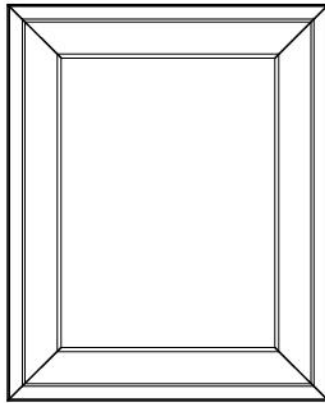

Small Drawer Front with 1 1/2" Framing 'SDF'

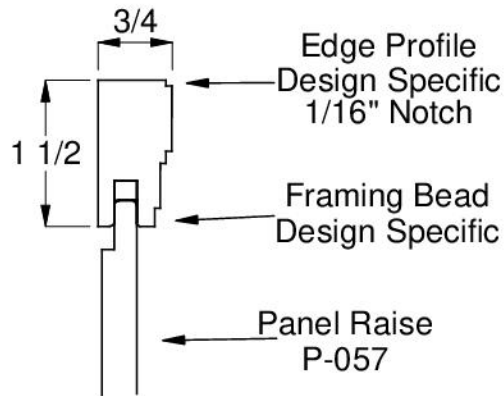

Large Drawer Front match door framing 'LDF'

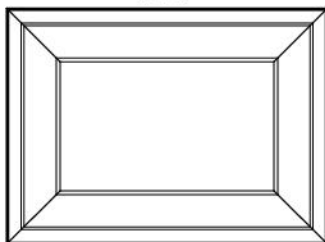

match door framing  
(see door detail above)



## Georgia Level 4

Framed	Frameless	Plywood	Furniture Board	Plain Inset	Beaded Inset	Full Overlay	Matching Drawer Front	Radius Door	Standard Hood Front	Concealed Hinge	Standard R.P. Arched Valance	Available Painted	Wainscot
								NA		NA			

Notes:

Minimum Size: 7-7/8"w x 7-5/8"h

Section Drawings of options available:

MDF Availability		
1 PC	2 PC	5 PC

### Georgia

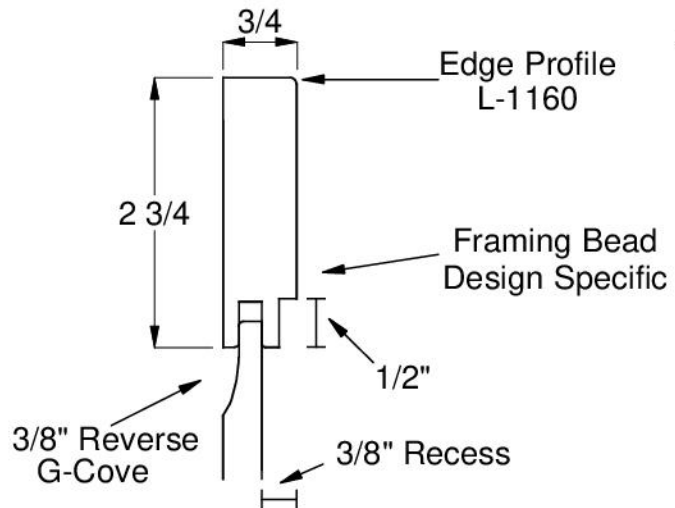
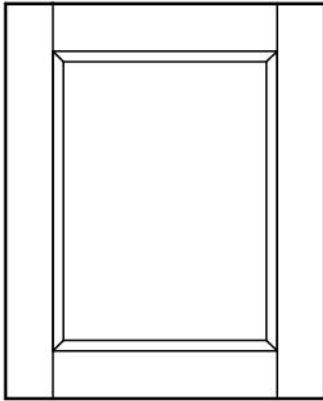

### Slab

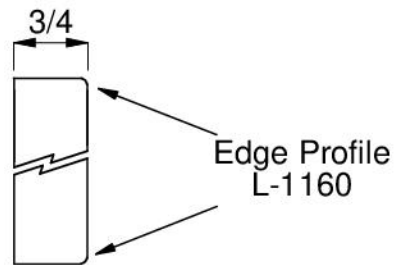
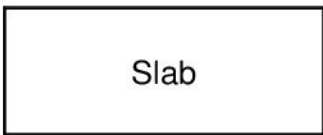

### Small Drawer Front with reduced rails 'SDF'

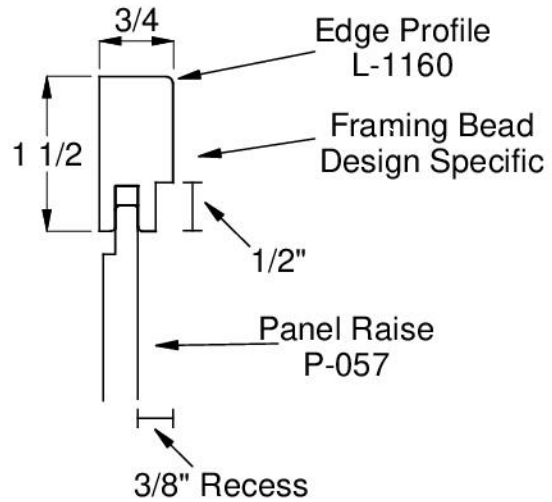
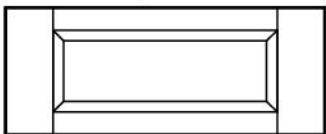

### Large Drawer Front match door framing 'LDF'

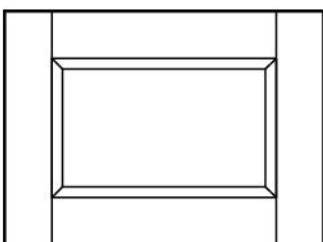

match door framing  
(see door detail above)

## Kingston Level 4



Framed	Frameless	Plywood	Furniture Board	Plain Inset	Beaded Inset	Full Overlay	Matching Drawer Front	Radius Door	Standard Hood Front	Concealed Hinge	Standard R.P. Arched Valance	Available Painted	Wainscot
									NA		NA		

Notes:

Minimum Size: 8"w x 10-1/8"h

Section Drawings of options available:

MDF Availability		
1 PC	2 PC	5 PC
NA	NA	NA

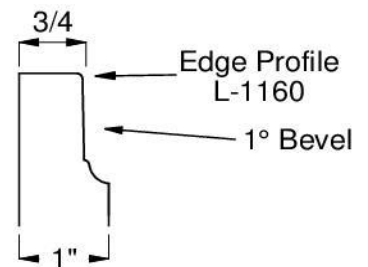
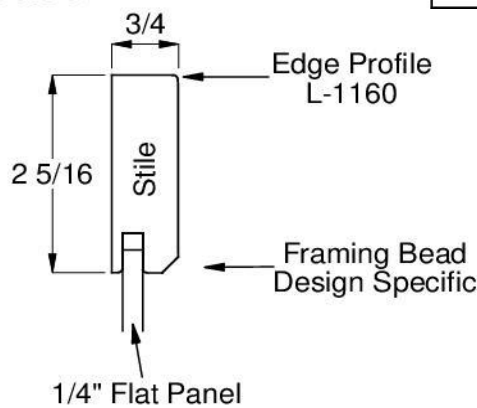
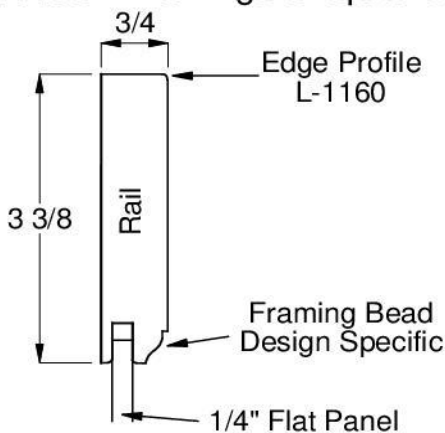

'SDF' and 'LDF' #10141 option

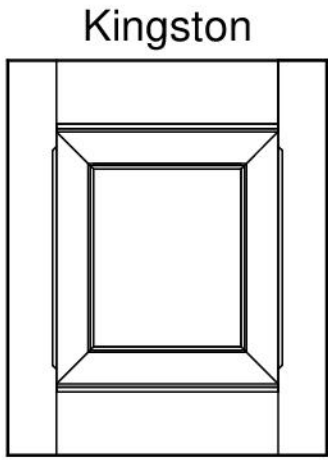

Kingston

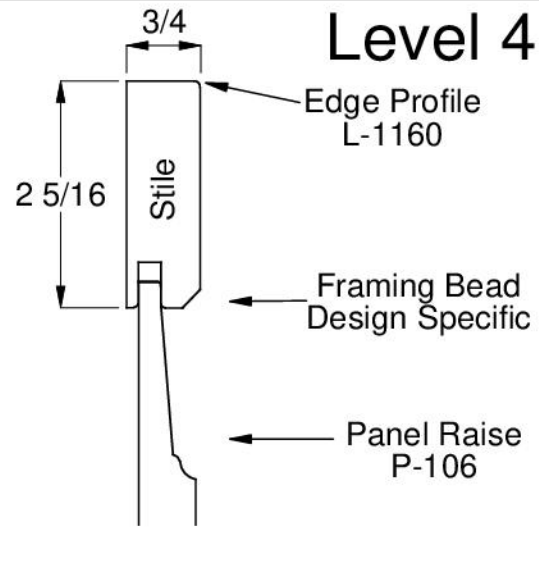
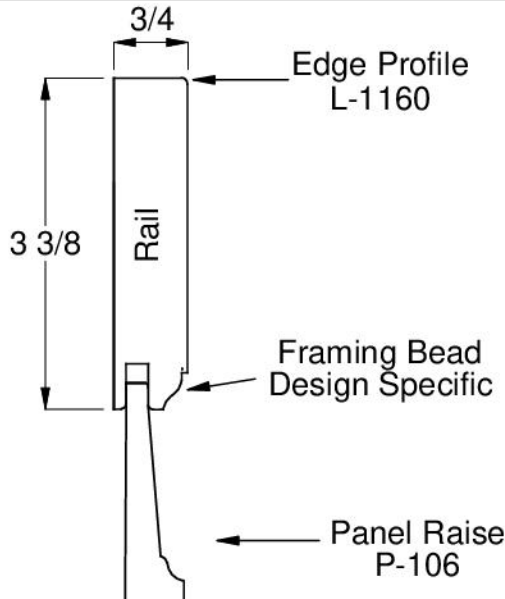

Level 4

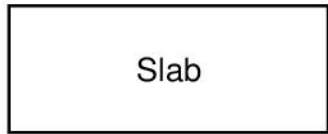

Slab

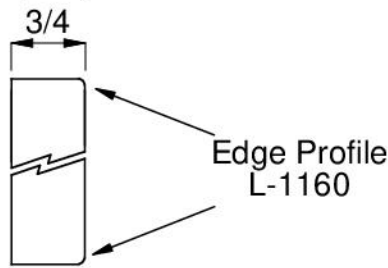

Small Drawer Front with Reduced rails 'SDF'

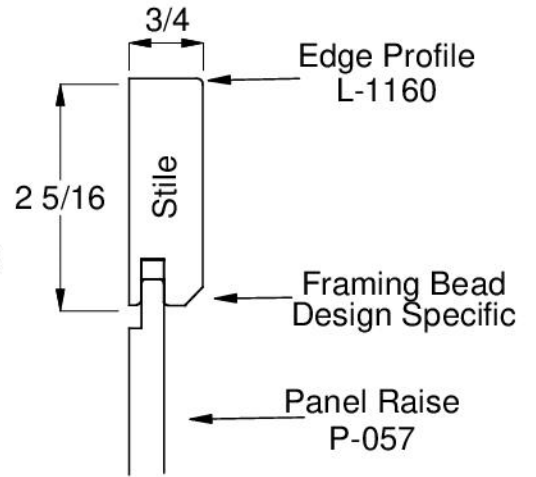
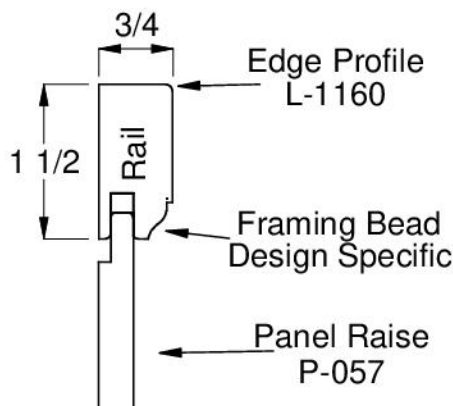
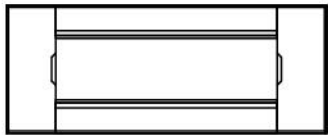

Large Drawer Front with 1 1/2 rails and P-106 panel raise 'LDF'

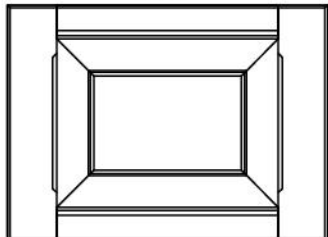

Large Drawer Front match door framing with P-106 panel raise 'LDF'

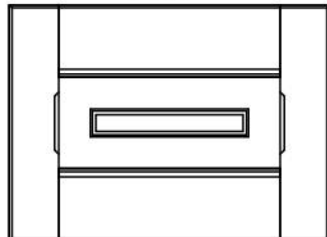

Large Drawer Front matches SDF framing and panel 'LDF'

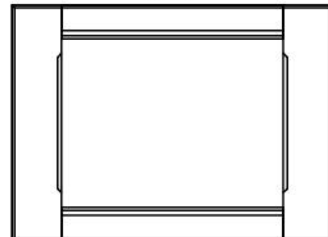



## Madison Level 4

Framed	Frameless	Plywood	Furniture Board	Plain Inset	Beaded Inset	Full Overlay	Matching Drawer Front	Radius Door	Standard Hood Front	Concealed Hinge	Standard R.P. Arched Valance	Available Painted	Wainscot
								NA		NA			

Notes:

Mullions available in regular and square framing bead profiles only.  
 Not available in rustic knotty wood species  
 Actual framing size may vary between 2-1/4" and 2-5/16"  
 depending on vendor selected by Wellsford.

Minimum Size: 7-3/16 "w x 7-3/16"h

MDF Availability		
1 PC	2 PC	5 PC
NA	NA	NA

Section Drawings of options available:

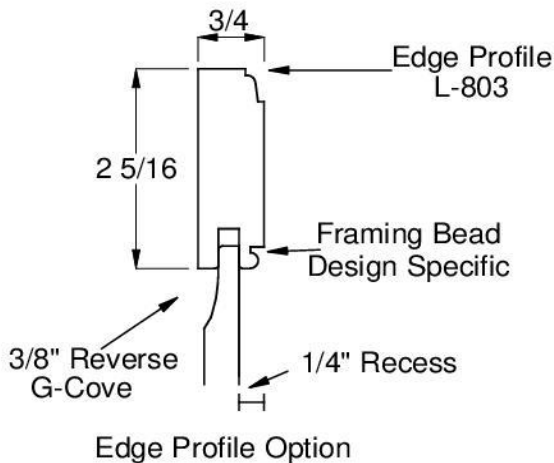



### Madison

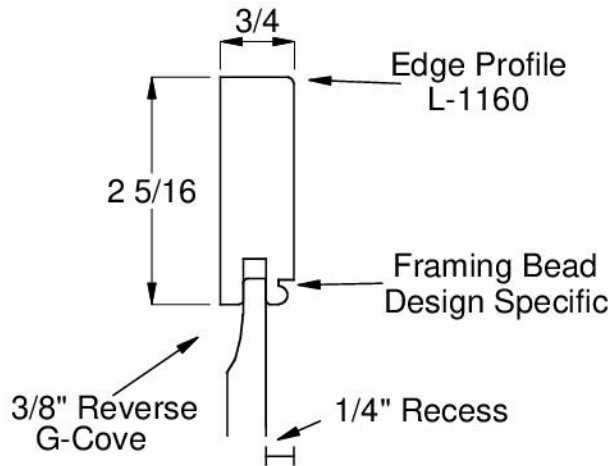
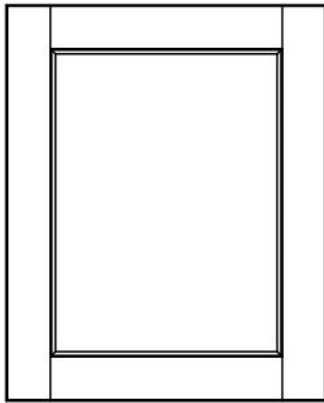

### Slab

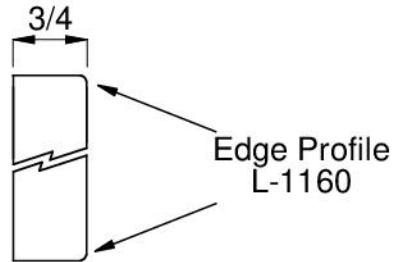

### Small Drawer Front With Reduced Rails 'SDF'

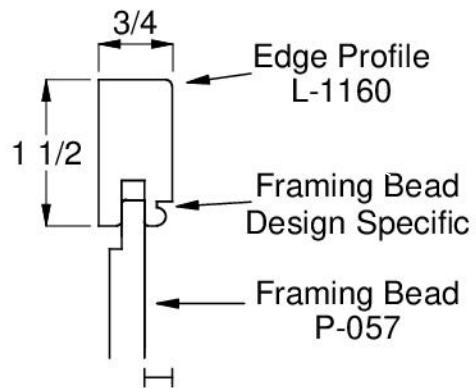
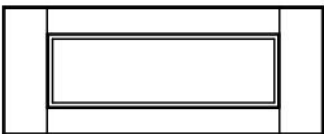

### Large Drawer Front match door framing 'LDF'

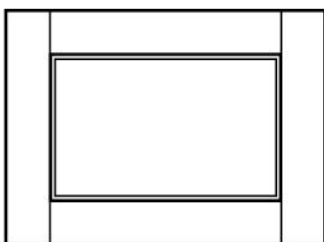

match door framing  
(see door detail above)



## Old Forge Level 4

Framed	Frameless	Plywood	Furniture Board	Plain Inset	Beaded Inset	Full Overlay	Matching Drawer Front	Radius Door	Standard Hood Front	Concealed Hinge	Standard R.P. Arched Valance	Available Painted	Wainscot
				NA	NA				NA		NA		NA

Notes:

Not available in rustic knotty wood species  
All 3/4" panel raises are available.

Minimum Size: 8"w x 8"h

Section Drawings of options available:

MDF Availability		
1 PC	2 PC	5 PC
NA	NA	

## Level 4

Old Forge

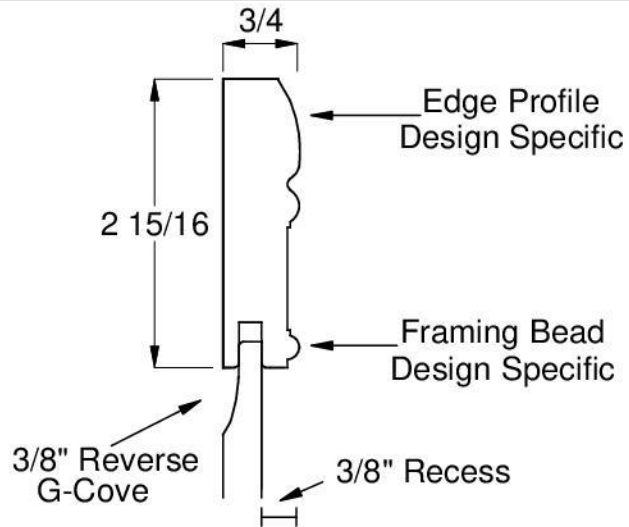
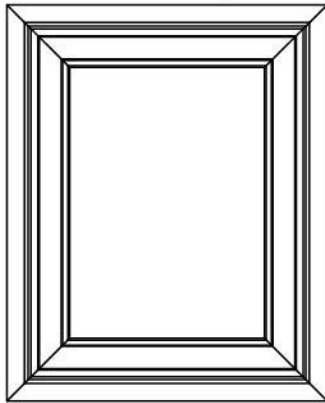

Slab

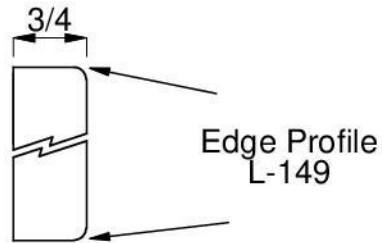

Small Drawer Front with 1 5/8 inch Framing 'SDF'

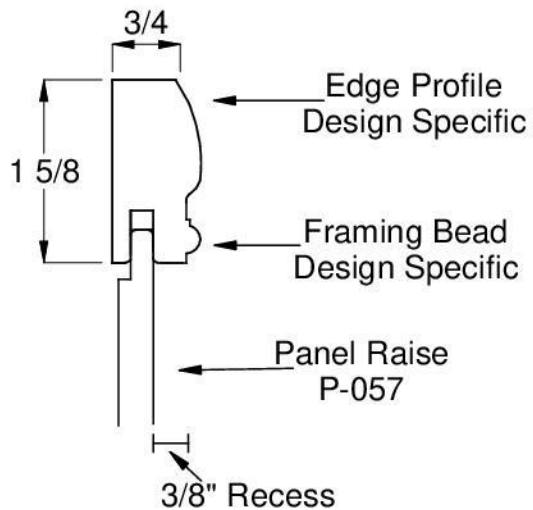
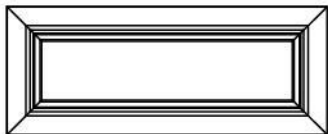

Large Drawer Front match door framing 'LDF'

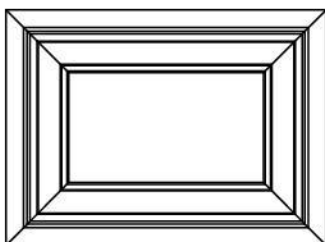

match door framing  
(see door detail above)



## Oslo Level 4

Framed	Frameless	Plywood	Furniture Board	Plain Inset	Beaded Inset	Full Overlay	Matching Drawer Front	Radius Door	Standard Hood Front	Concealed Hinge	Standard R.P. Arched Valance	Available Painted	Wainscot
				NA	NA				NA		NA		NA

Notes:

Mullions available in square bead only

Minimum Size: 7" w x 8-1/8" h

MDF Availability		
1 PC	2 PC	5 PC
		NA

Section Drawings of options available:

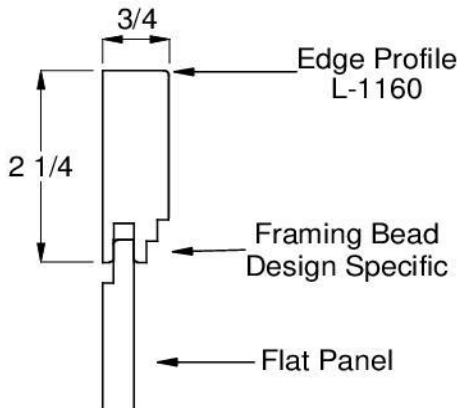

Edge Profile Option

Oslo

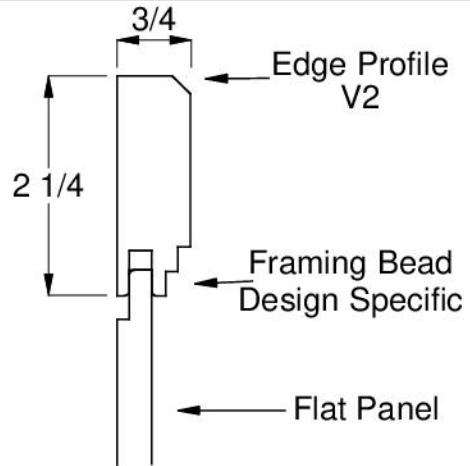
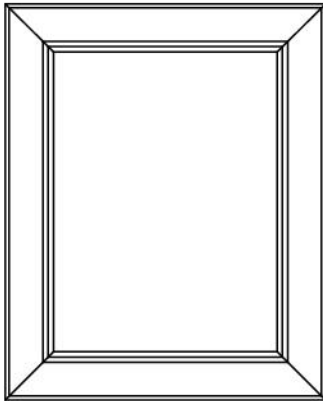

Slab

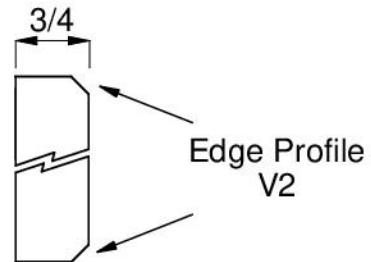

Small Drawer Front with reduced rails  
'SDF'

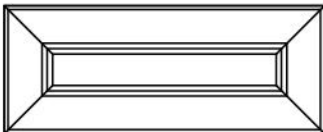

match door framing  
(see door detail above)

Large Drawer Front  
match door framing  
'LDF'

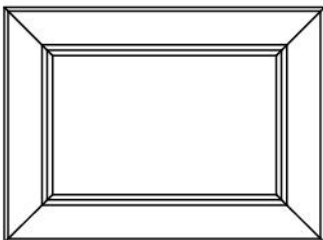

match door framing  
(see door detail above)



## Provencal Level 4

Framed	Frameless	Plywood	Furniture Board	Plain Inset	Beaded Inset	Full Overlay	Matching Drawer Front	Radius Door	Standard Hood Front	Concealed Hinge	Standard R.P. Arched Valance	Available Painted	Wainscot
				NA	NA				NA		NA		NA

Notes:

Not available in rustic knotty wood species.  
 Mullions available in regular bead profile only.  
 All 3/4" panel raises are available.

Minimum Size: 8-5/8"w x 8-5/8"h

Section Drawings of options available:

MDF Availability		
1 PC	2 PC	5 PC
NA	NA	

Provencal

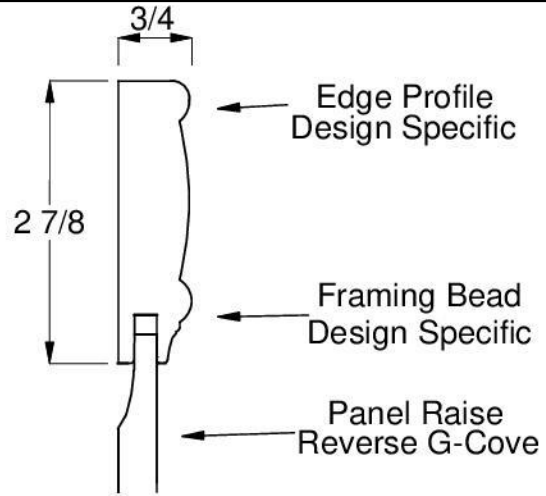
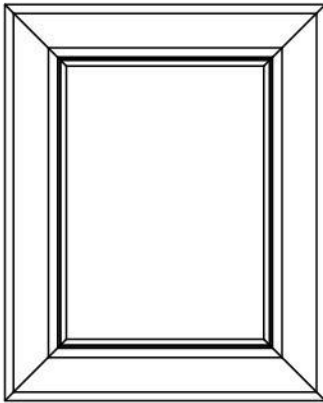

Slab

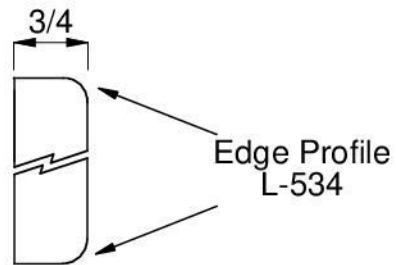
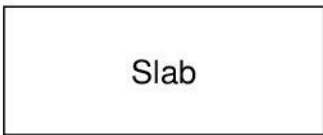

Small Drawer Front with 2" framing 'SDF'

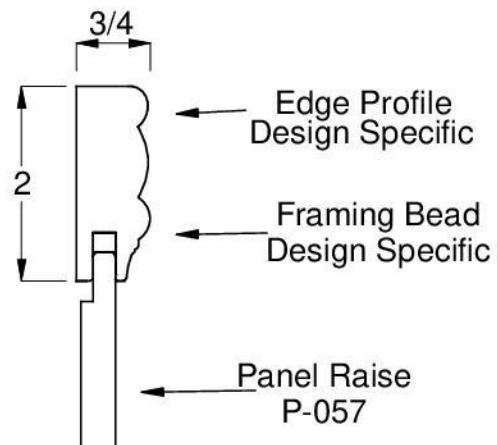
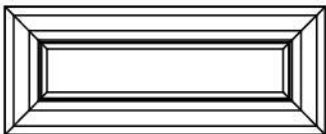

Large Drawer Front match door framing 'LDF'

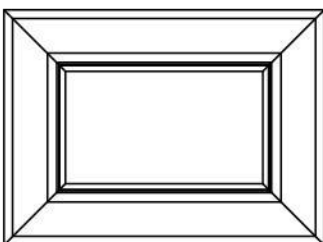

match door framing  
(see door detail above)

## Rutland Level 4



Framed	Frameless	Plywood	Furniture Board	Plain Inset	Beaded Inset	Full Overlay	Matching Drawer Front	Radius Door	Standard Hood Front	Concealed Hinge	Standard R.P. Arched Valance	Available Painted	Wainscot
				NA	NA				NA		NA		NA

Notes:  
Not available in bamboo or rustic knotty wood species.

Minimum Size: 7-1/2" w x 7-1/2" h

MDF Availability		
1 PC	2 PC	5 PC
NA	NA	NA

Section Drawings of options available:

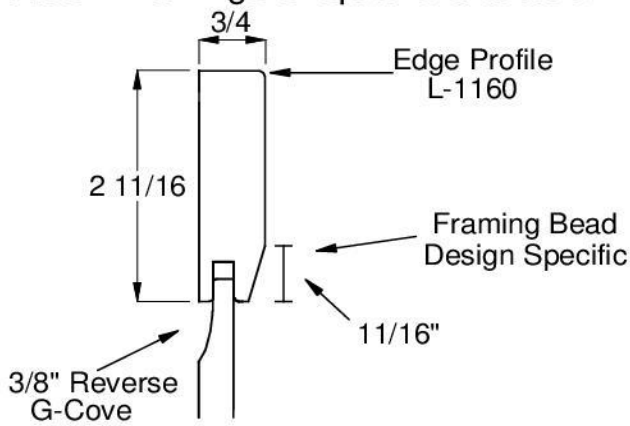

Door Panel Option

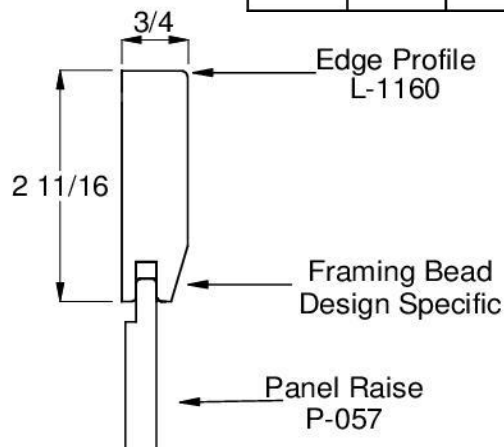

Door Panel Option



Rutland

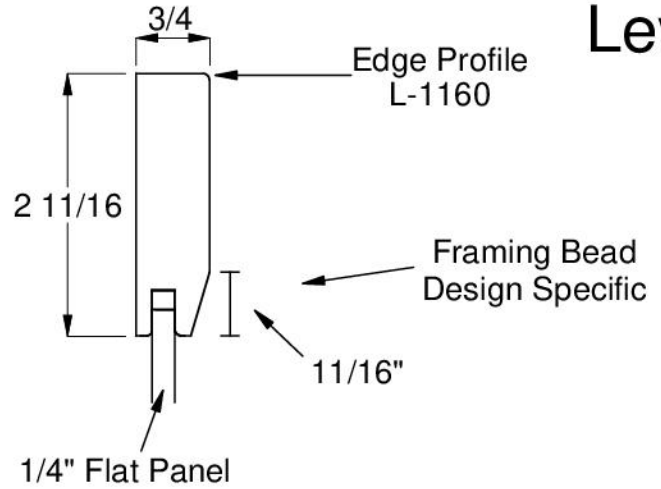
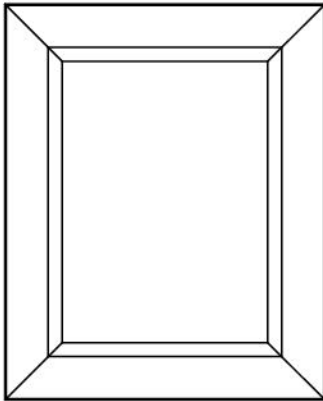

Slab

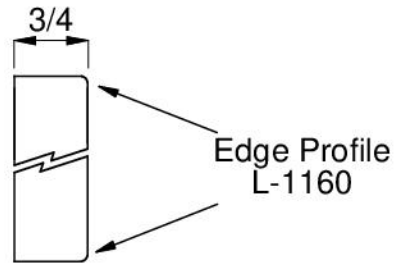

Small Drawer Front with  
2 1/16 Framing  
'SDF'

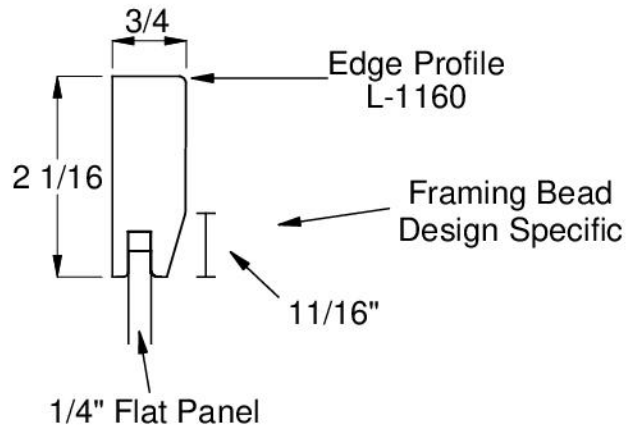
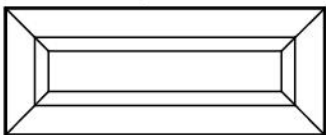

Large Drawer Front with  
match door framing  
'LDF'

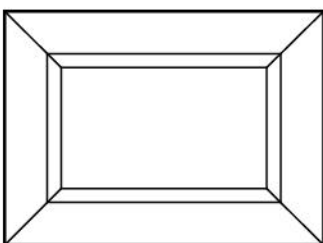

match door framing  
(see door detail above)



## Wakefield Level 4

Framed	Frameless	Plywood	Furniture Board	Plain Inset	Beaded Inset	Full Overlay	Matching Drawer Front	Radius Door	Standard Hood Front	Concealed Hinge	Standard R.P. Arched Valance	Available Painted	Wainscot
								NA		NA			

Notes:

Mullions available in square bead only

Minimum Size: 7"w x 8-1/8"h

MDF Availability		
1 PC	2 PC	5 PC
NA	NA	NA

Section Drawings of options available:

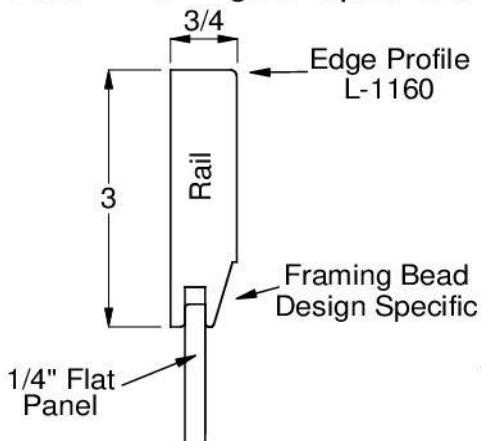

Door Panel Option

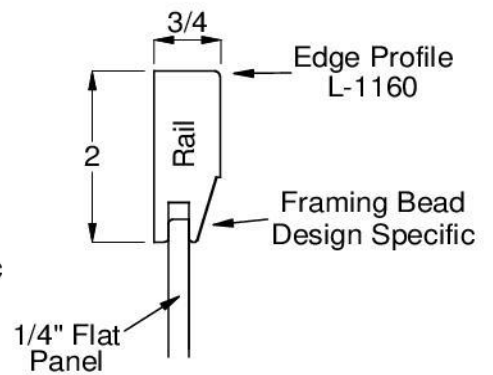
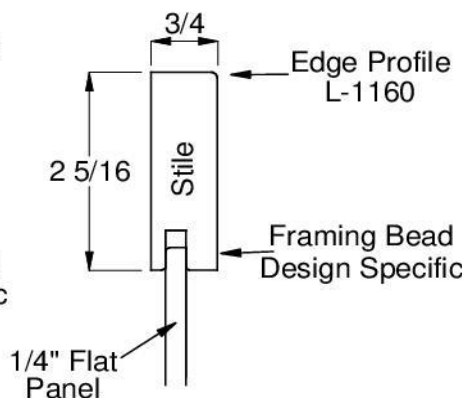

Drawer Panel Option

## Wakefield

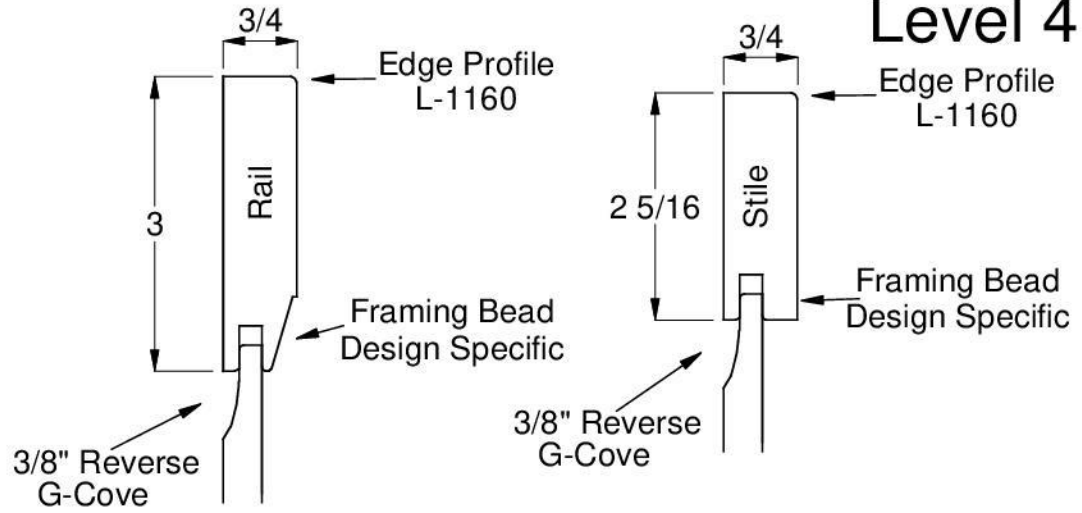
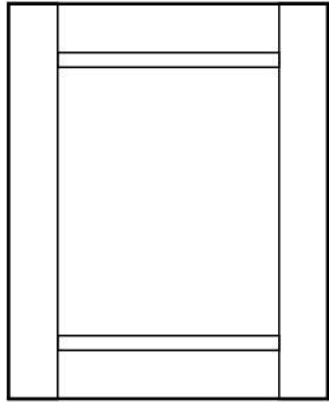

## Level 4

## Slab

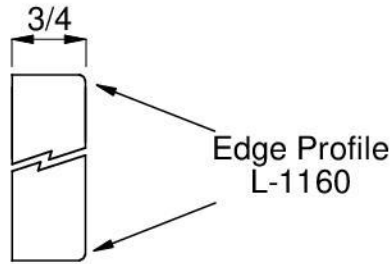
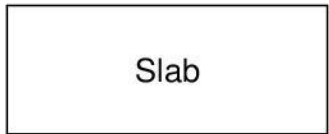

## Small Drawer Front with Reduced rails 'SDF'

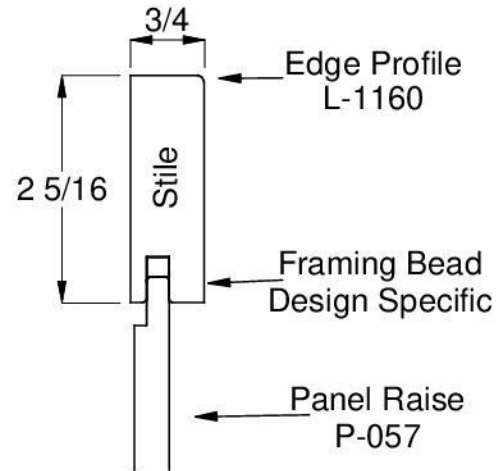
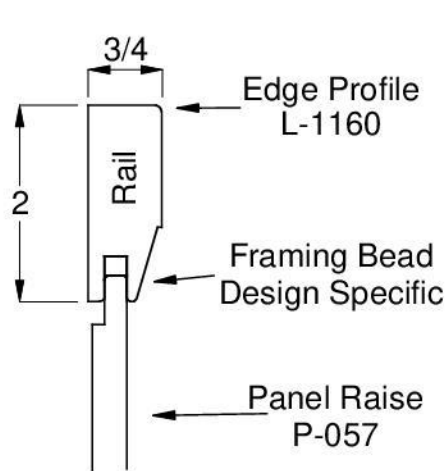
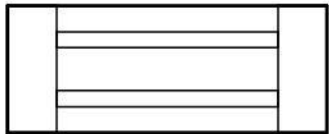

## Large Drawer Front match door framing 'LDF'

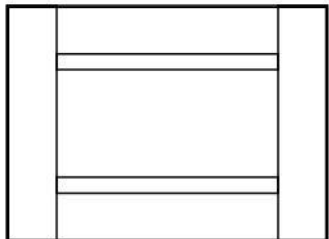

match door framing  
(see door detail above)



## NOTES



# LEVEL 5



## Aspen Level 5

Framed	Frameless	Plywood	Furniture Board	Plain Inset	Beaded Inset	Full Overlay	Matching Drawer Front	Radius Door	Standard Hood Front	Concealed Hinge	Standard R.P. Arched Valance	Available Painted	Wainscot
				NA	NA			NA	NA		NA		NA

Notes:

Available in: cherry, hard maple, paint grade, red oak, rift cut white oak, walnut only.  
Not available with glass doors.

Minimum Size: 4"w x 4"h

Section Drawings of options available:

MDF Availability		
1 PC	2 PC	5 PC
NA	NA	NA

Aspen

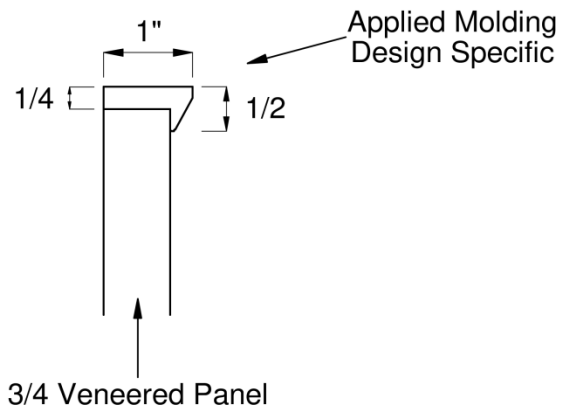
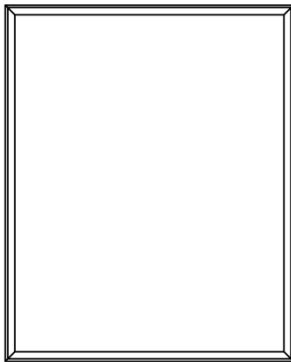

Matching Drawer front only  
'SDF' and 'LDF'

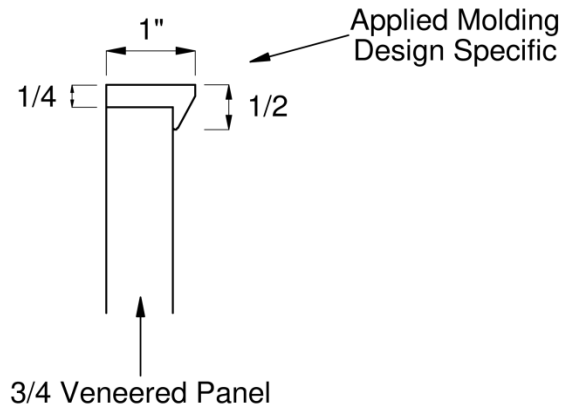
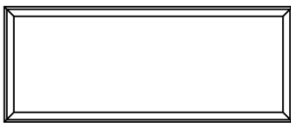



## Boulder Level 5

Framed	Frameless	Plywood	Furniture Board	Plain Inset	Beaded Inset	Full Overlay	Matching Drawer Front	Radius Door	Standard Hood Front	Concealed Hinge	Standard R.P. Arched Valance	Available Painted	Wainscot
				NA	NA			NA	NA		NA		NA

Notes:

Available in: cherry, hard maple, paint grade, red oak, rift cut white oak, walnut only.  
 Not available with glass doors.

Minimum Size: 4"w x 4"h

Section Drawings of options available:

MDF Availability		
1 PC	2 PC	5 PC
NA	NA	NA



Boulder

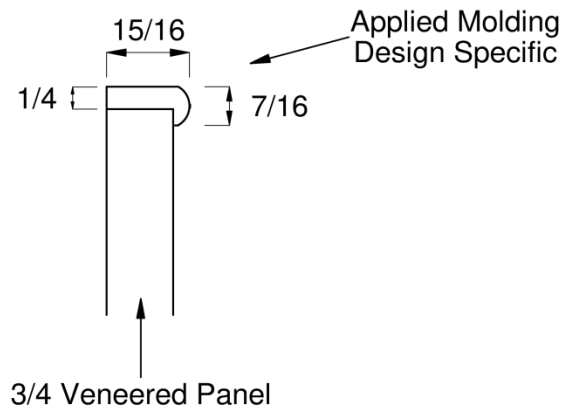
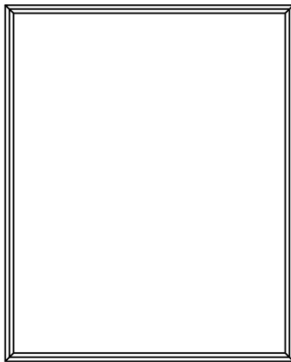

Matching Drawer front only  
'SDF' and 'LDF'

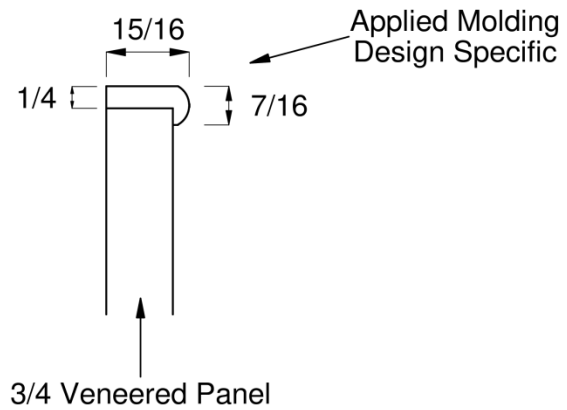



## Edgemont Level 5

Framed	Frameless	Plywood	Furniture Board	Plain Inset	Beaded Inset	Full Overlay	Matching Drawer Front	Radius Door	Standard Hood Front	Concealed Hinge	Standard R.P. Arched Valance	Available Painted	Wainscot
								NA		NA			

Notes:  
Available with square mullion bead profile only.

Minimum Size: 8-1/2"w. x 8-1/2"h.

MDF Availability		
1 PC	2 PC	5 PC

Section Drawings of options available:

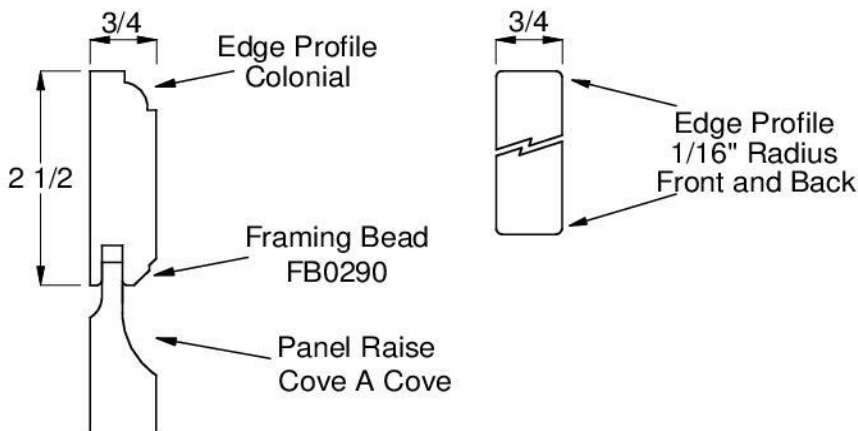

Door Edge Profile Option

Edgemont

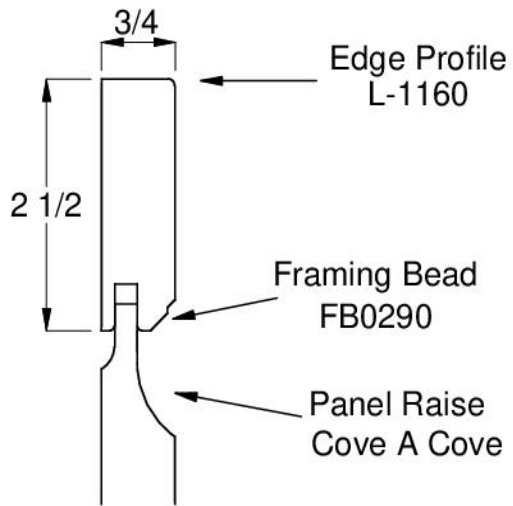
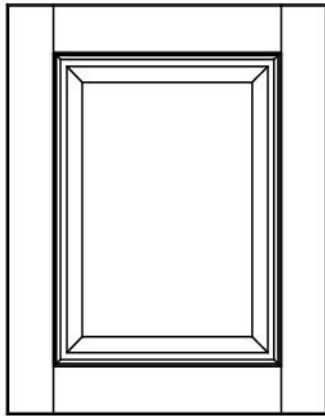

Slab

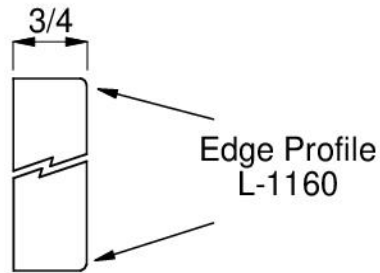

Small Drawer Front with reduced rails 'SDF'

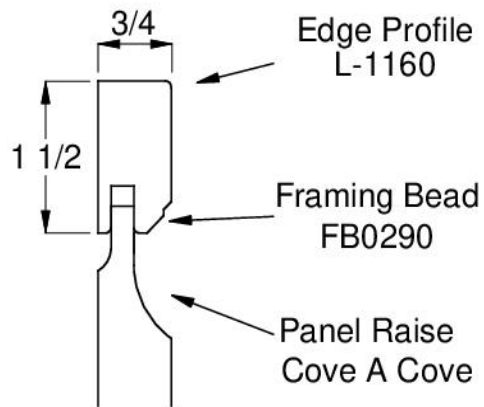
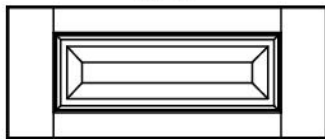

Large Drawer Front match door framing 'LDF'

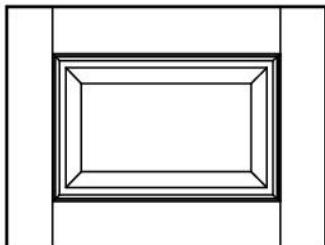

match door framing  
(see door detail above)



## Edgemont RE Level 5

Framed	Frameless	Plywood	Furniture Board	Plain Inset	Beaded Inset	Full Overlay	Matching Drawer Front	Radius Door	Standard Hood Front	Concealed Hinge	Standard R.P. Arched Valance	Available Painted	Wainscot
								NA		NA			

Notes:  
Available with square mullion bead profile only.

Minimum Size: 7"w. x 5"h.

MDF Availability		
1 PC	2 PC	5 PC

Section Drawings of options available:

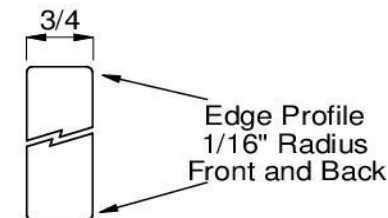
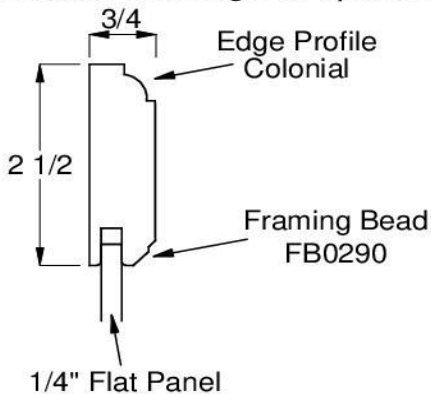

Door Edge Profile Option

Door Edge Profile Option

Edgemont RE

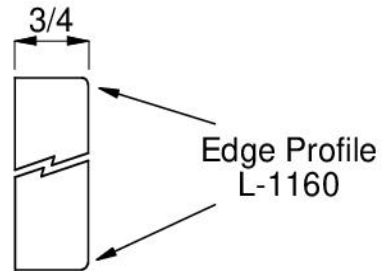
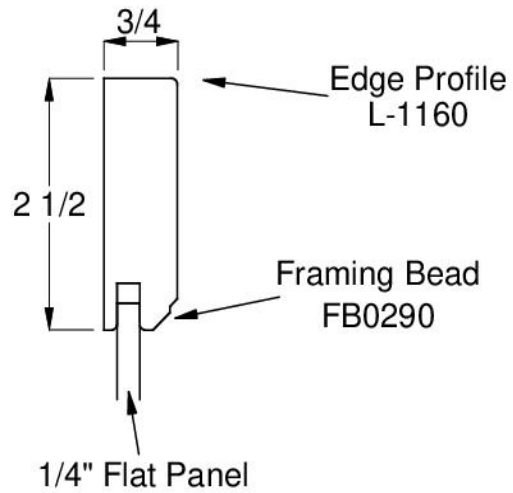
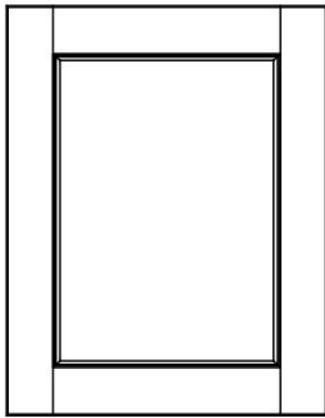

Small Drawer Front with reduced rails 'SDF'

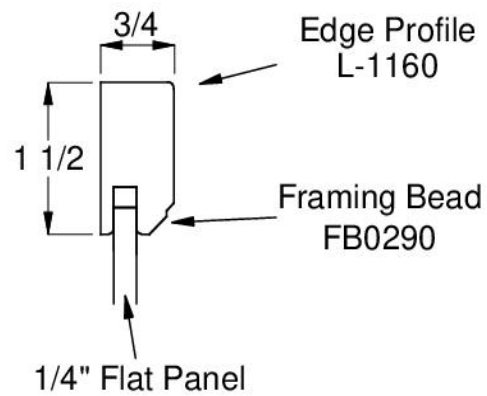
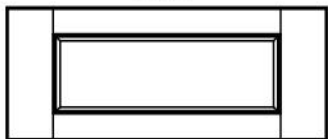

Large Drawer Front match door framing 'LDF'

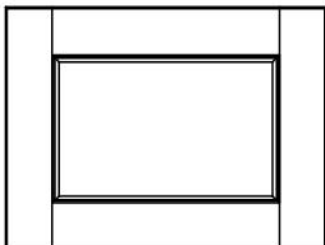

match door framing  
(see door detail above)



## Oxford Level 5

Framed	Frameless	Plywood	Furniture Board	Plain Inset	Beaded Inset	Full Overlay	Matching Drawer Front	Radius Door	Standard Hood Front	Concealed Hinge	Standard R.P. Arched Valance	Available Painted	Wainscot
									NA		NA		

**Notes:**  
 Available with regular mullion bead profile only.  
 Actual framing size may vary between 2-1/4" and 2-5/16" depending on vendor selected by Wellsford.

Minimum Size: 7"w. x 6-3/4"h.

MDF Availability		
1 PC	2 PC	5 PC
NA	NA	NA

Section Drawings of options available:

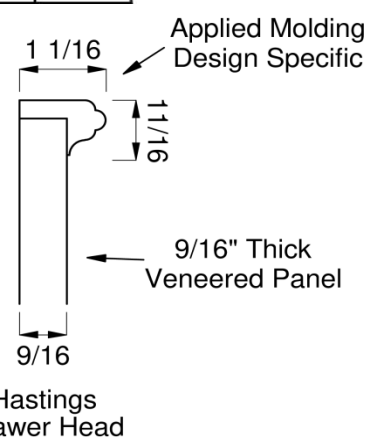
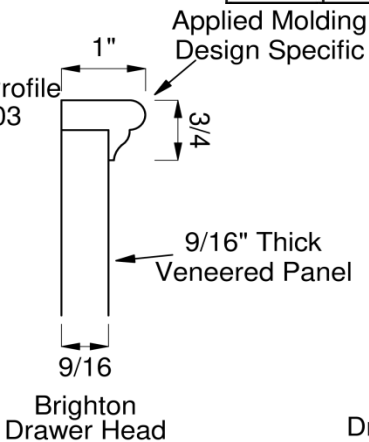
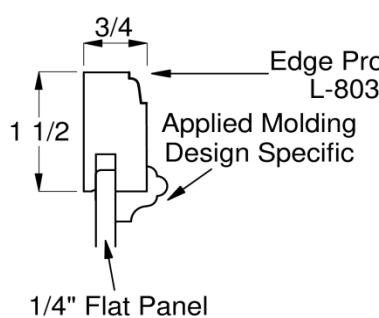
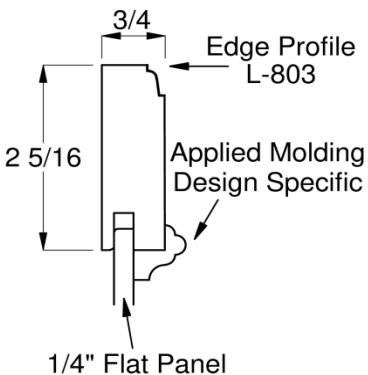

Door and Drawer Panel and Edge Profile Option

Oxford

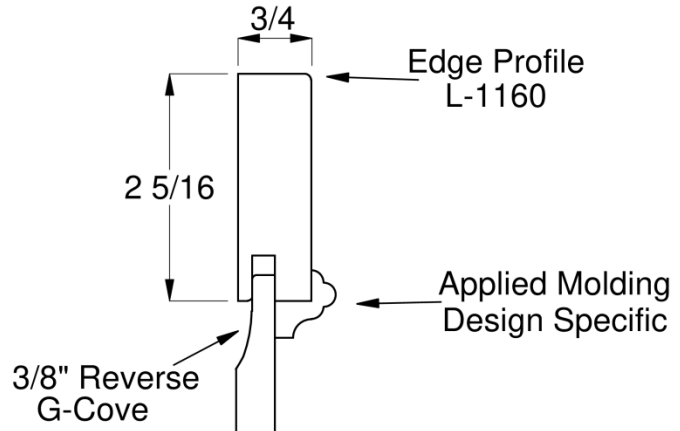
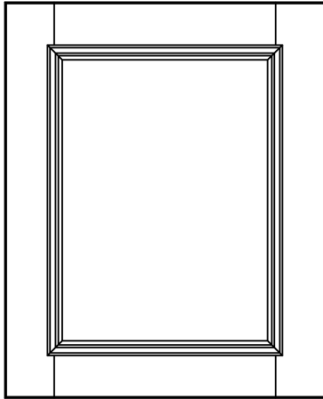

Slab

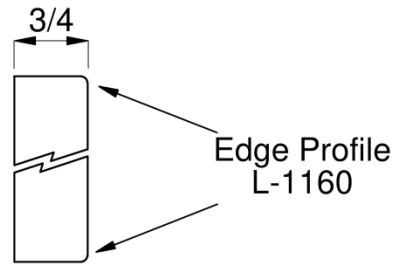
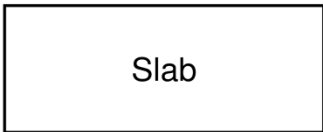

Small Drawer Front with Reduced Rails 'SDF'

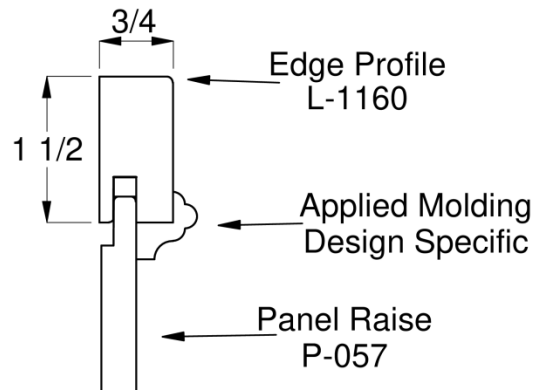
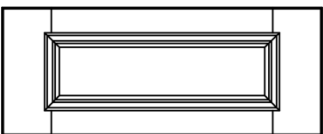

Large Drawer Front match door framing 'LDF'

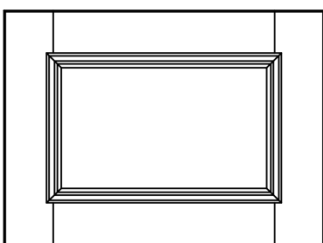

match door framing  
(see door detail above)

## Presidio Level 5



Framed	Frameless	Plywood	Furniture Board	Plain Inset	Beaded Inset	Full Overlay	Matching Drawer Front	Radius Door	Standard Hood Front	Concealed Hinge	Standard R.P. Arched Valance	Available Painted	Wainscot
								NA		NA			

Notes:  
Available with square mullion bead profile only.

Minimum Size: 8-1/2"w. x 8-1/2"h.

MDF Availability		
1 PC	2 PC	5 PC

Section Drawings of options available:

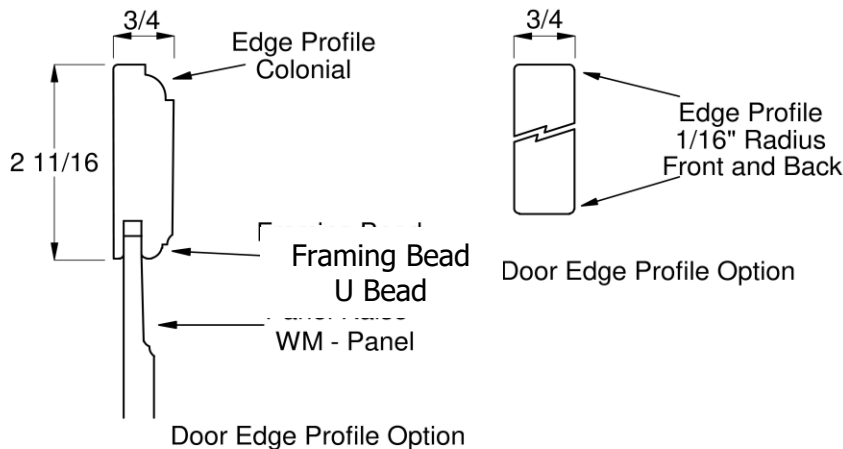



### Presidio

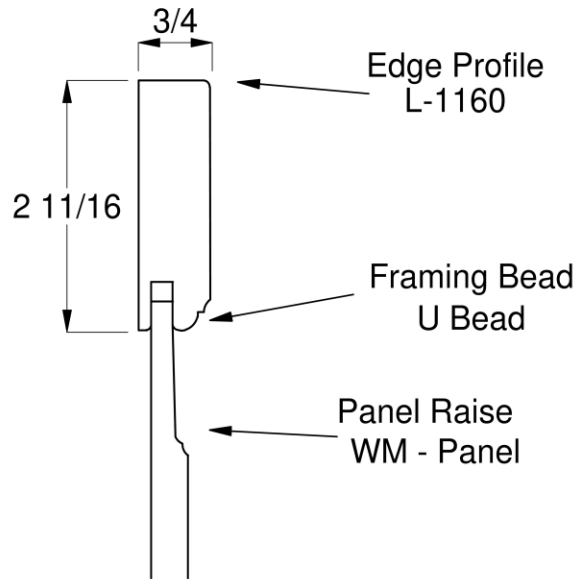
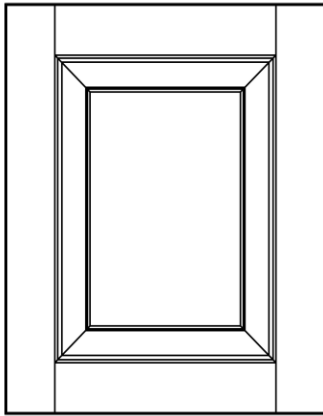

### Slab

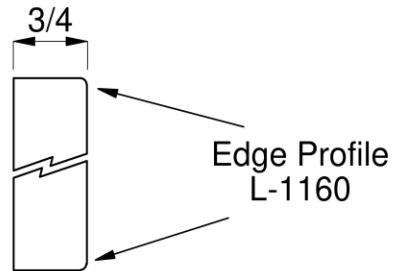
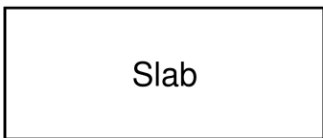

### Small Drawer Front with reduced rails 'SDF'

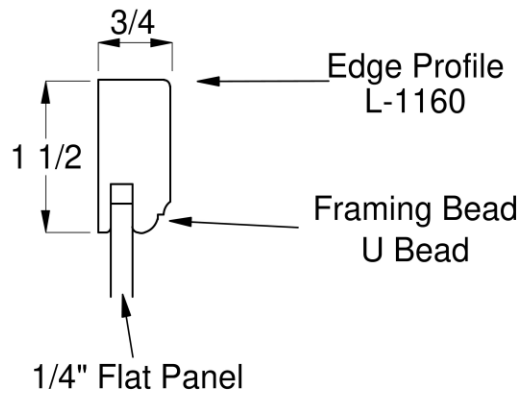
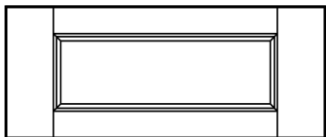

### Large Drawer Front match door framing 'LDF'

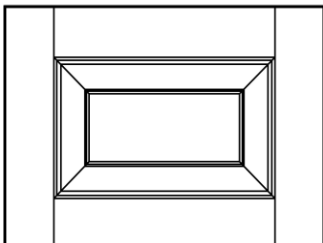

match door framing  
(see door detail above)



## Presidio RE Level 5

Framed	Frameless	Plywood	Furniture Board	Plain Inset	Beaded Inset	Full Overlay	Matching Drawer Front	Radius Door	Standard Hood Front	Concealed Hinge	Standard R.P. Arched Valance	Available Painted	Wainscot
									NA		NA		

Notes:

Available with square mullion bead profile only.

Minimum Size: 7"w. x 5"h.

MDF Availability		
1 PC	2 PC	5 PC

Section Drawings of options available:

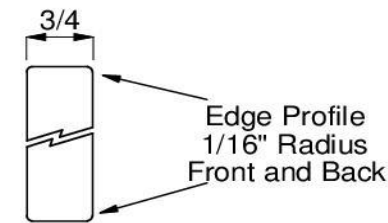
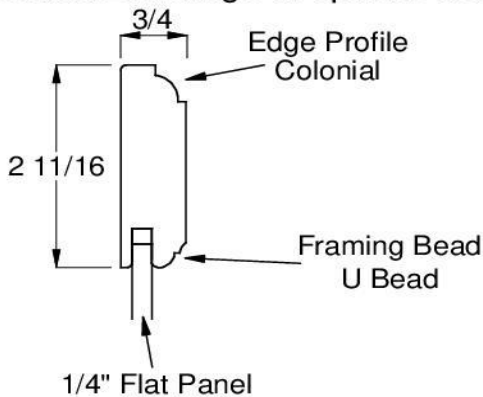

Door Edge Profile Option

Door Edge Profile Option

Presidio RE

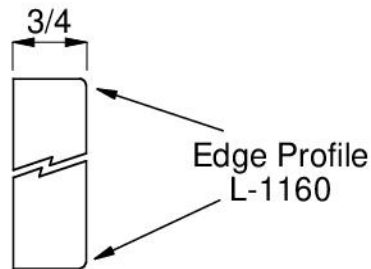
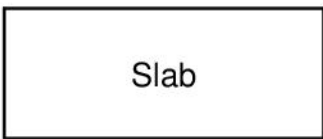
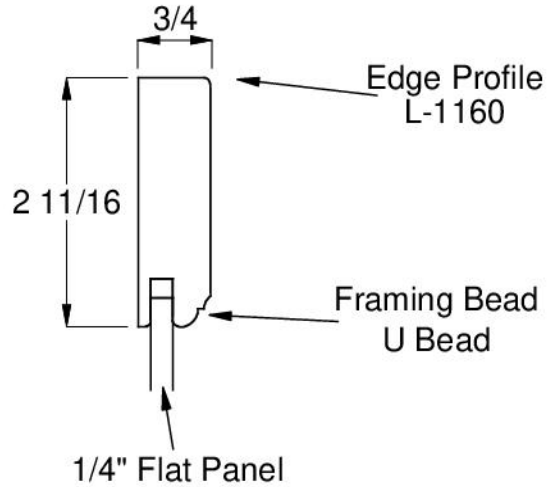
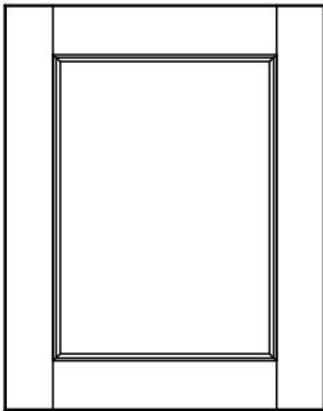

Small Drawer Front with reduced rails 'SDF'

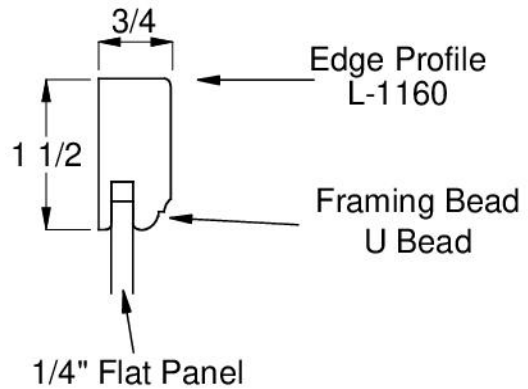
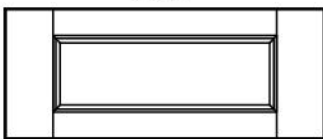

Large Drawer Front match door framing 'LDF'

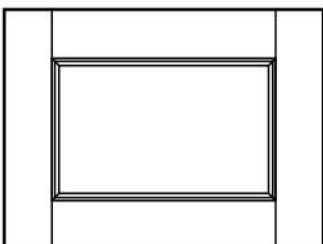

match door framing  
(see door detail above)



## Topeka Level 5

<i>Framed</i>	<i>Frameless</i>	<i>Plywood</i>	<i>Furniture Board</i>	<i>Plain Inset</i>	<i>Beaded Inset</i>	<i>Full Overlay</i>	<i>Matching Drawer Front</i>	<i>Radius Door</i>	<i>Standard Hood Front</i>	<i>Concealed Hinge</i>	<i>Standard R.P. Arched Valance</i>	<i>Available Painted</i>	<i>Wainscot</i>
				NA	NA			NA	NA		NA		NA

**Notes:**

Available in: cherry, hard maple, paint grade, red oak, rift cut white oak, walnut only.  
 Not available with glass doors.

Minimum Size: 4"w. x 4"h.

Section Drawings of options available:

MDF Availability		
1 PC	2 PC	5 PC
NA	NA	NA

Topeka

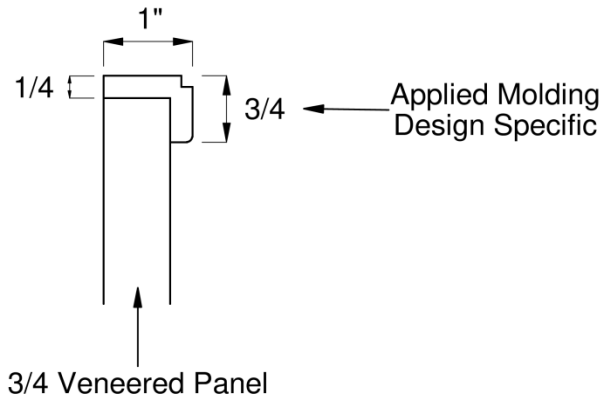
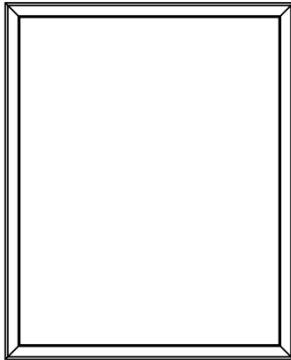

Matching Drawer front only  
'SDF' and 'LDF'

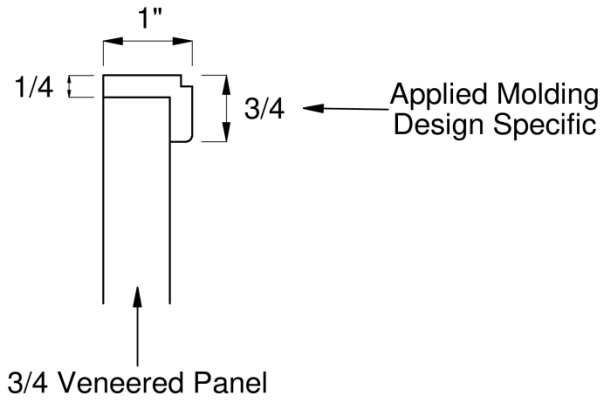



## Verona Level 5

Framed	Frameless	Plywood	Furniture Board	Plain Inset	Beaded Inset	Full Overlay	Matching Drawer Front	Radius Door	Standard Hood Front	Concealed Hinge	Standard R.P. Arched Valance	Available Painted	Wainscot
								NA		NA			

**Notes:**

Available with regular mullion bead profile only.  
 Actual framing size may vary between 2-1/4" and 2-5/16" depending on vendor selected by Wellsford.

Minimum Size: 7-1/4"w. x 7-1/4"h.

MDF Availability		
1 PC	2 PC	5 PC
NA	NA	NA

Section Drawings of options available:

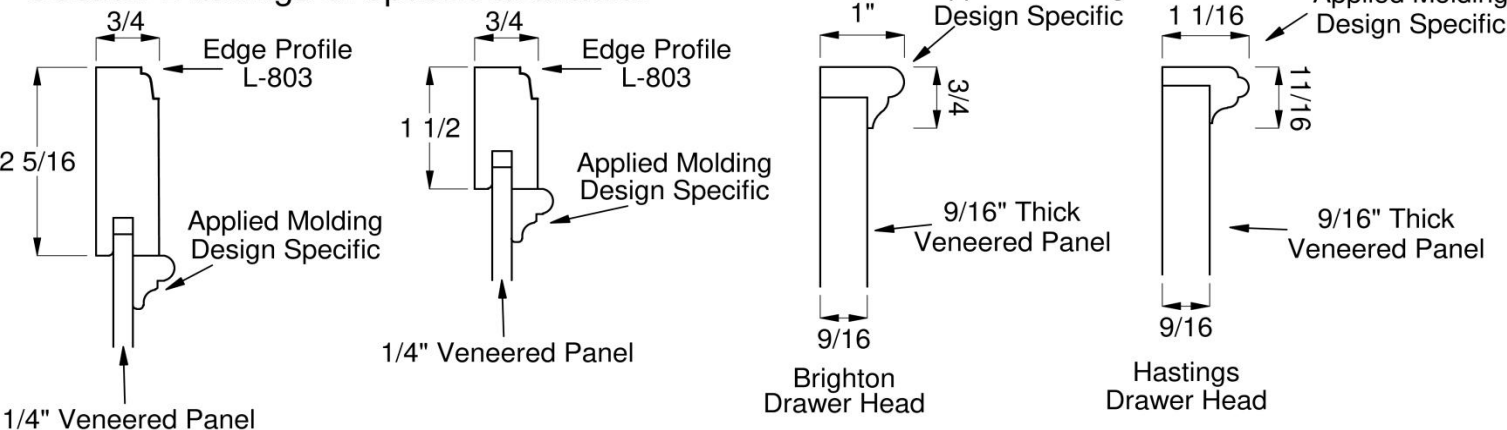

Door and Door Edge Profile Option

Verona

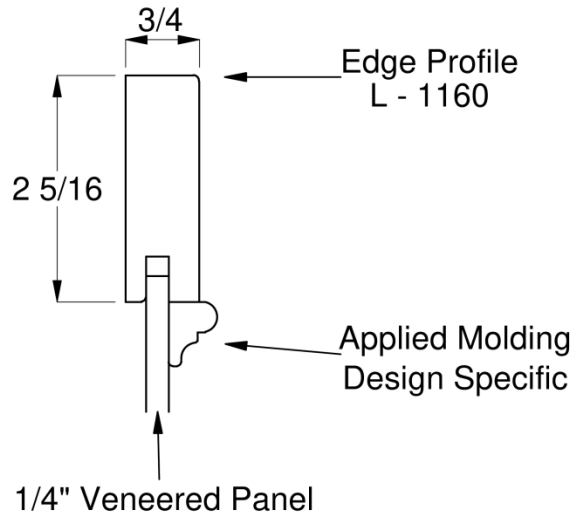
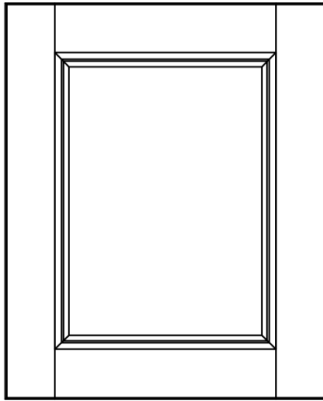

Slab

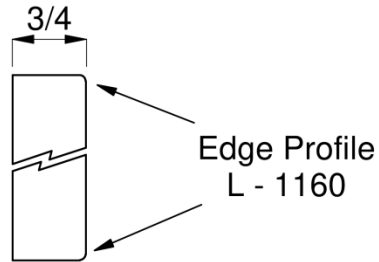
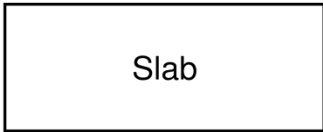

Small Drawer Front with reduced rails 'SDF'

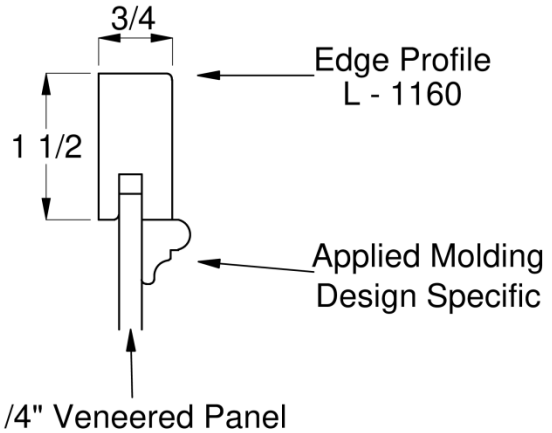
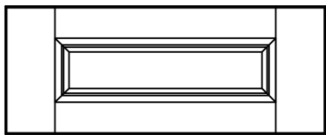

Large Drawer Front match door framing 'LDF'

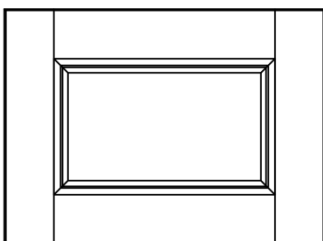

match door framing  
(see door detail above)



## Wayland Level 5

Framed	Frameless	Plywood	Furniture Board	Plain Inset	Beaded Inset	Full Overlay	Matching Drawer Front	Radius Door	Standard Hood Front	Concealed Hinge	Standard R.P. Arched Valance	Available Painted	Wainscot
								NA		NA			

Notes:

Square mullion bead is standard.  
 Regular mullion bead is available as custom quote.  
 Actual framing size may vary between 2-1/4" and 2-5/16" depending on vendor selected by Wellsford.

Minimum Size: 7"w. x 6-3/4"h.

MDF Availability		
1 PC	2 PC	5 PC
NA	NA	NA

Section Drawings of options available:

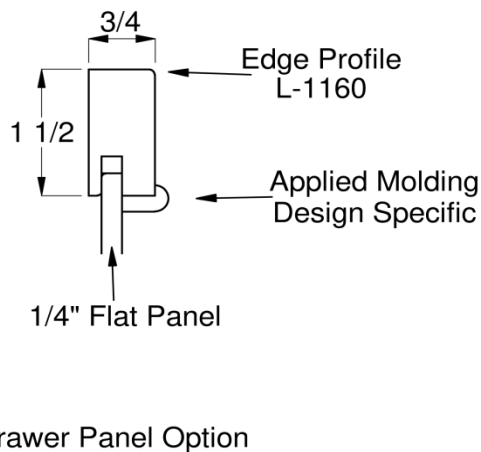
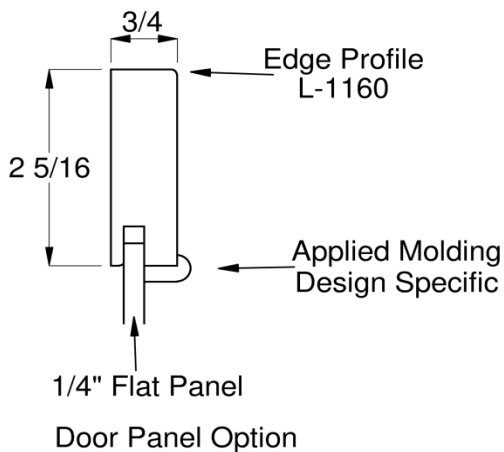



Wayland

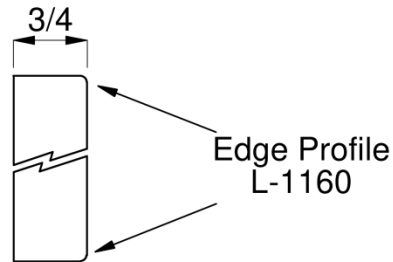
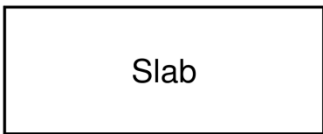
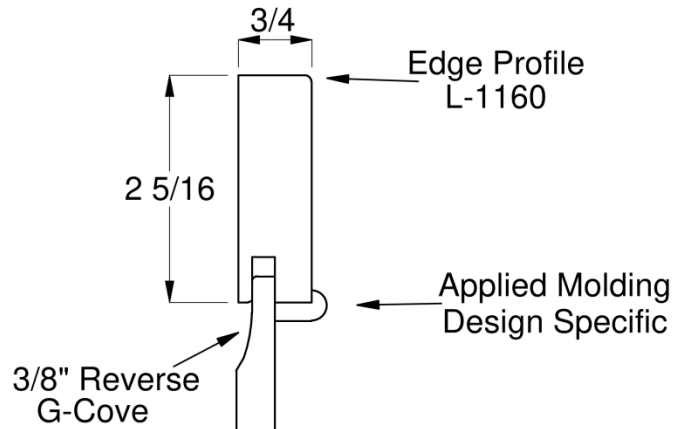
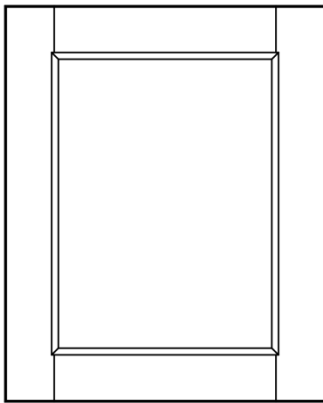

Small Drawer Front with Reduced Rails 'SDF'

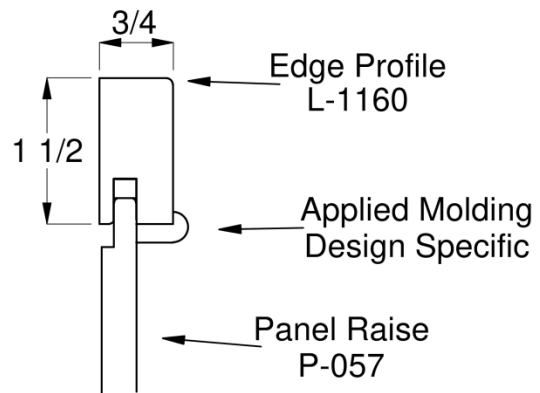
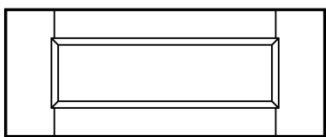

Large Drawer Front match door framing 'LDF'

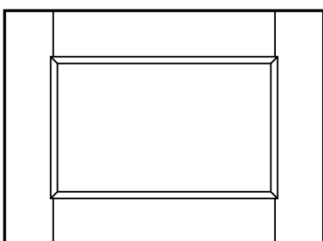

match door framing  
(see door detail above)



## Woodridge Level 5

<i>Framed</i>	<i>Frameless</i>	<i>Plywood</i>	<i>Furniture Board</i>	<i>Plain Inset</i>	<i>Beaded Inset</i>	<i>Full Overlay</i>	<i>Matching Drawer Front</i>	<i>Radius Door</i>	<i>Standard Hood Front</i>	<i>Concealed Hinge</i>	<i>Standard R.P. Arched Valance</i>	<i>Available Painted</i>	<i>Wainscot</i>
				NA	NA			NA	NA		NA		NA

**Notes:**

Available with square mullion bead only.  
Not available in rustic knotty woods.

Minimum Size: 9-7/16"w. x 9-7/16"h.

Section Drawings of options available:

MDF Availability		
1 PC	2 PC	5 PC
NA	NA	NA

## Level 5

Woodridge

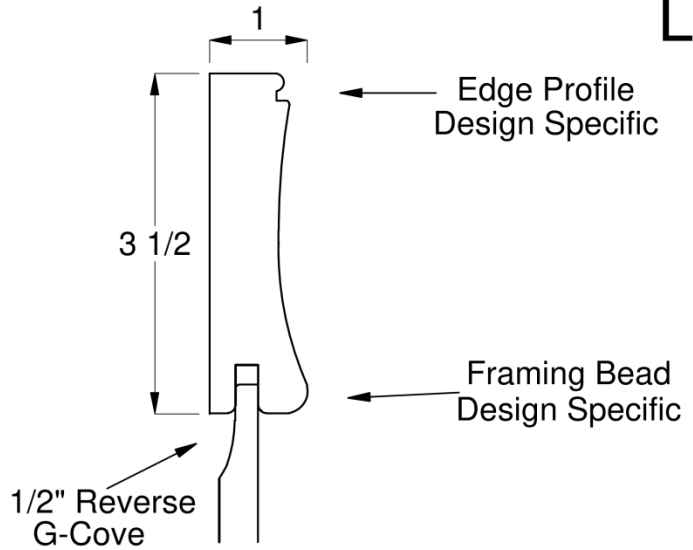
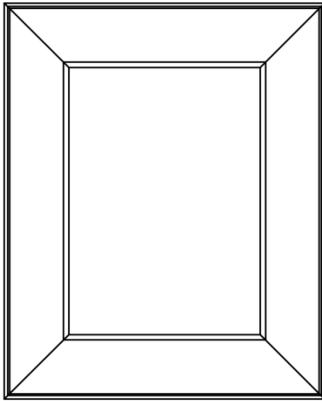

Slab

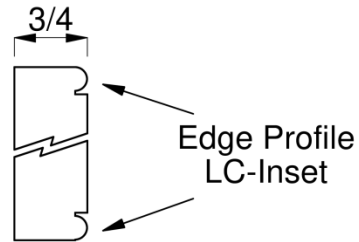
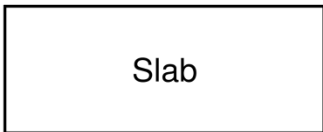

Small Drawer Front with 2" Framing 'SDF'

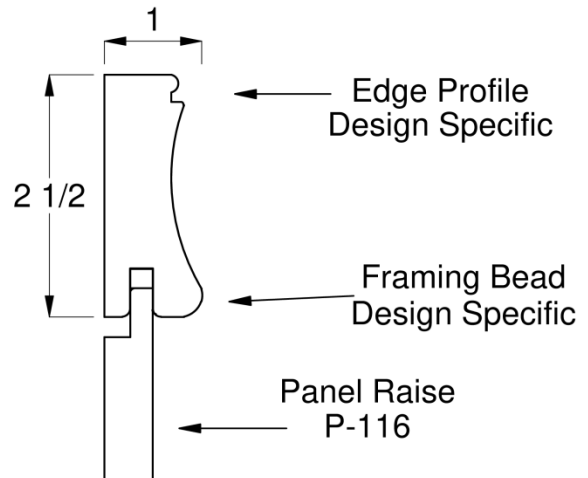
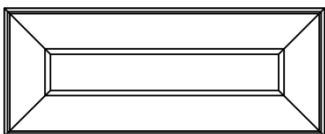

Large Drawer Front match door framing 'LDF'

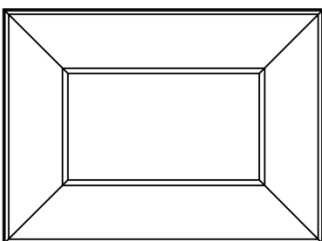

match door framing  
(see door detail above)



## NOTES



# LEVEL 6



## Barcelona Level 6

Framed	Frameless	Plywood	Furniture Board	Plain Inset	Beaded Inset	Full Overlay	Matching Drawer Front	Radius Door	Standard Hood Front	Concealed Hinge	Standard R.P. Arched Valance	Available Painted	Wainscot
								NA		NA			

Notes:

Available with regular mullion bead profile only.

Minimum Size: 9-5/8"w. x 9-5/8"h.

MDF Availability		
1 PC	2 PC	5 PC
NA	NA	NA

Section Drawings of options available:

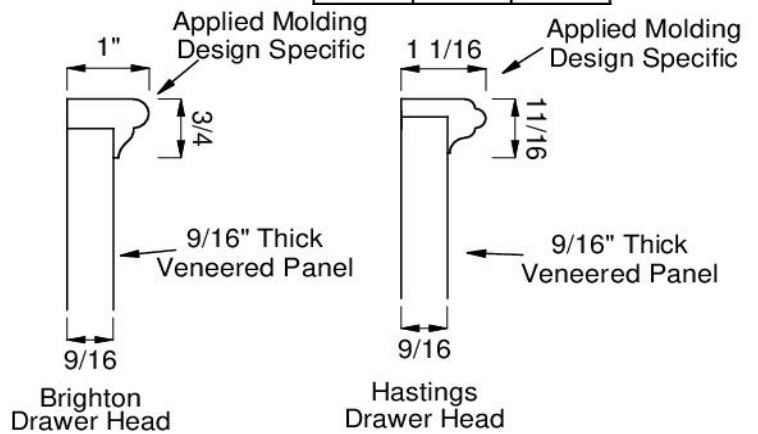
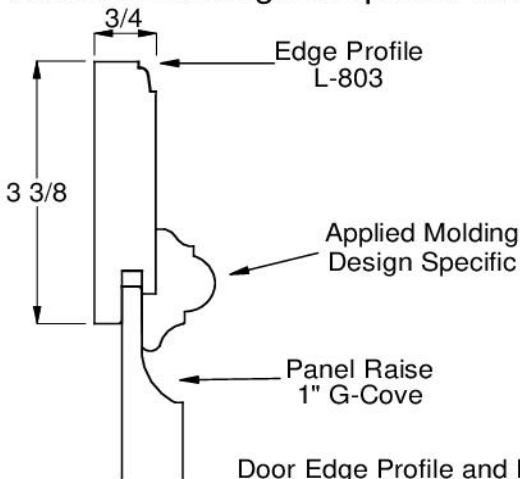

## Level 6

Barcelona

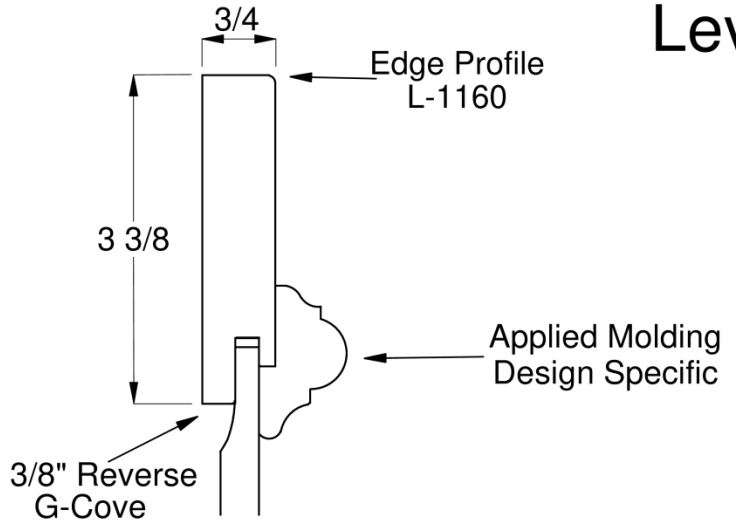
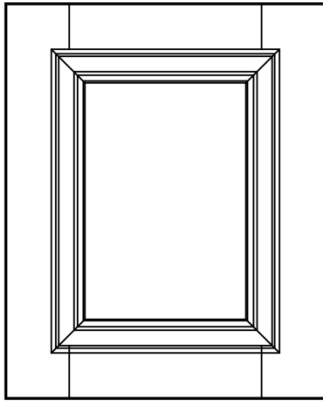

Slab

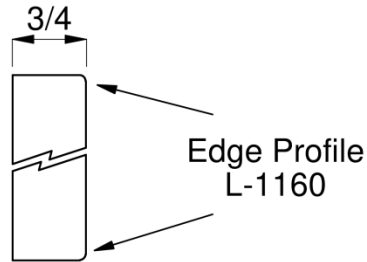
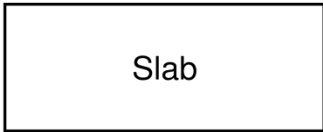

Small Drawer Front with  
2 5/16" Rails  
'SDF'

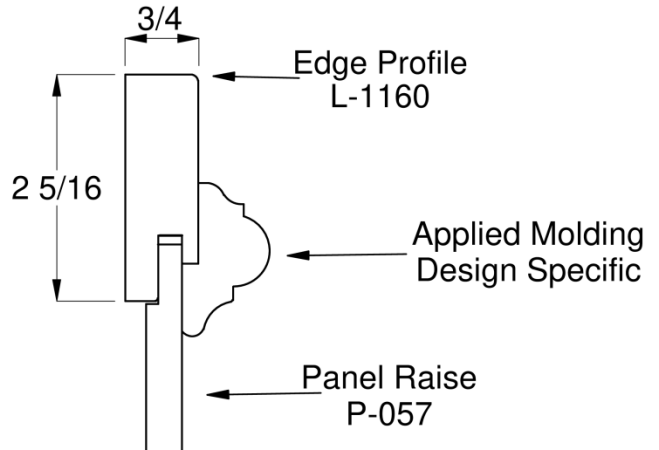
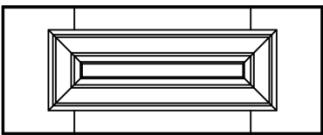

Large Drawer Front  
match door framing  
'LDF'

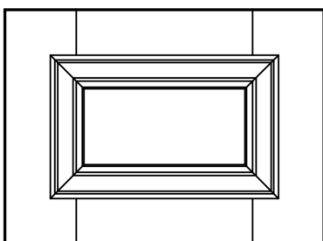

match door framing  
(see door detail above)

## Bellevue Level 6



Framed	Frameless	Plywood	Furniture Board	Plain Inset	Beaded Inset	Full Overlay	Matching Drawer Front	Radius Door	Standard Hood Front	Concealed Hinge	Standard R.P. Arched Valance	Available Painted	Wainscot
								NA		NA			

Notes:

Available with matching mullion bead profile only.  
1-1/2" rails on SDF available as custom quote.

Minimum Size: 8-5/8"w x 8-5/8"h

MDF Availability		
1 PC	2 PC	5 PC
NA	NA	NA

Section Drawings of options available:

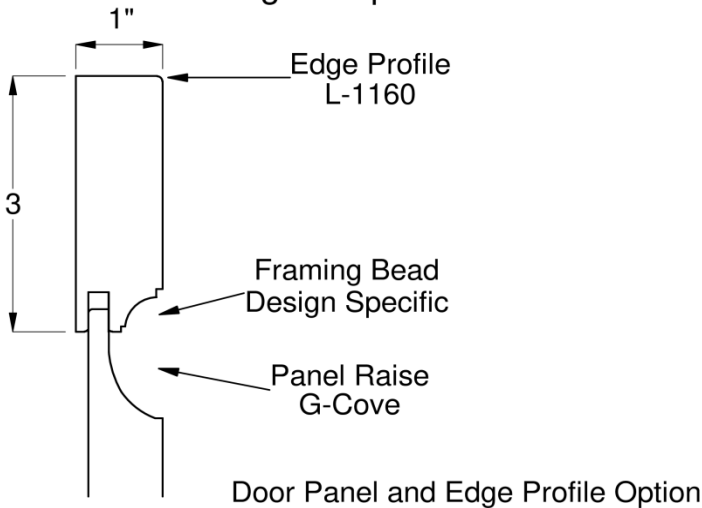



Bellevue

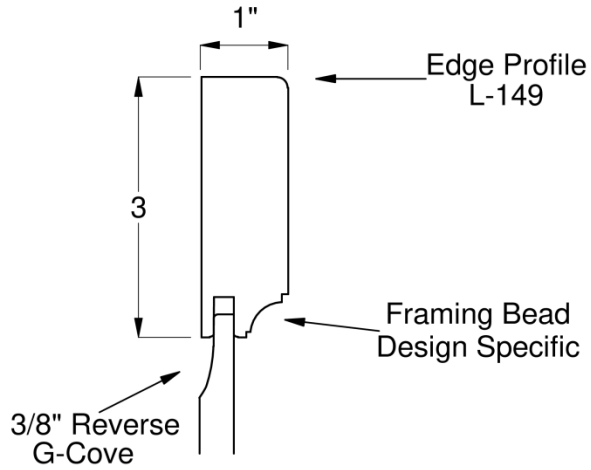
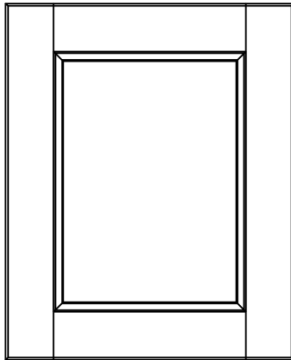

Slab

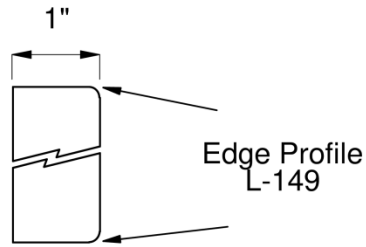
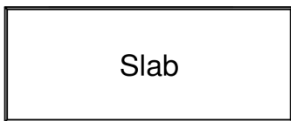

Small Drawer Front with reduced rails 'SDF'

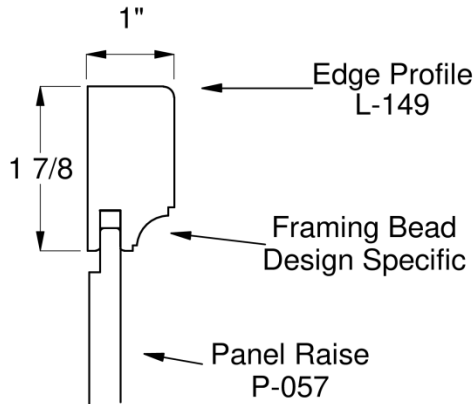
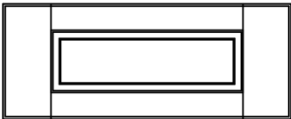

Large Drawer Front match door framing 'LDF'

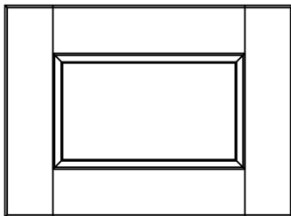

match door framing  
(see door detail above)



## Brandywine Level 6

Framed	Frameless	Plywood	Furniture Board	Plain Inset	Beaded Inset	Full Overlay	Matching Drawer Front	Radius Door	Standard Hood Front	Concealed Hinge	Standard R.P. Arched Valance	Available Painted	Wainscot
								NA	NA		NA		

Notes:

Not available with mullions.

Minimum Size: 8-7/8"w. x 8-7/8"h.

MDF Availability		
1 PC	2 PC	5 PC
NA	NA	NA

Section Drawings of options available:

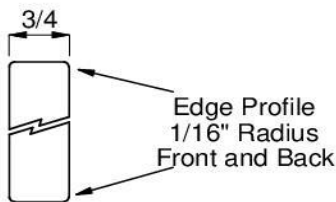

Door Edge Profile Option

## Level 6

Brandywine

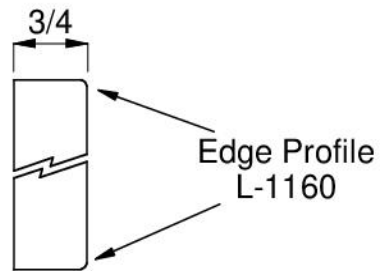
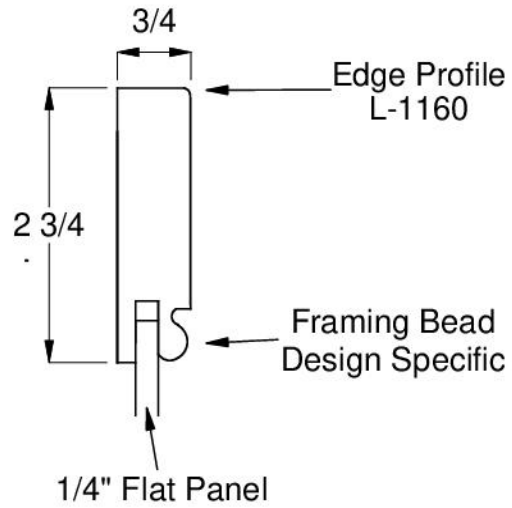
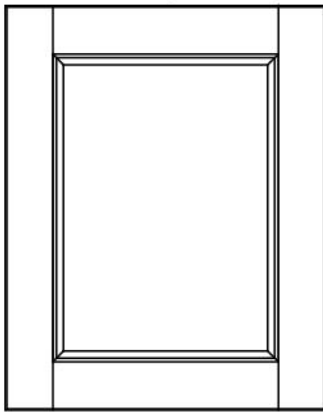

Small Drawer Front with Reduced Rails 'SDF'

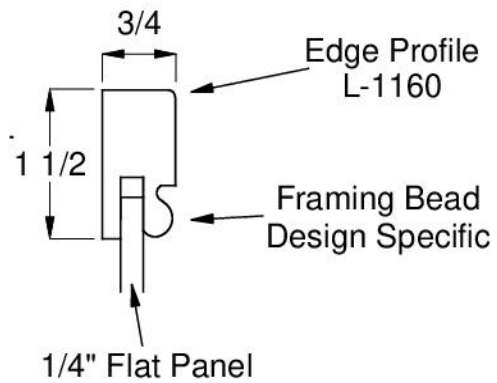
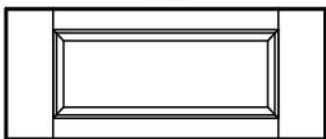

Large Drawer Front match door framing 'LDF'

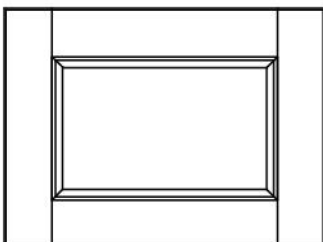

match door framing  
(see door detail above)

## Churchill Level 6



Framed	Frameless	Plywood	Furniture Board	Plain Inset	Beaded Inset	Full Overlay	Matching Drawer Front	Radius Door	Standard Hood Front	Concealed Hinge	Standard R.P. Arched Valance	Available Painted	Wainscot

Notes:

Minimum Size:

8-7/8"w. x 8-7/8"h.

Section Drawings of options available:

MDF Availability		
1 PC	2 PC	5 PC
NA	NA	

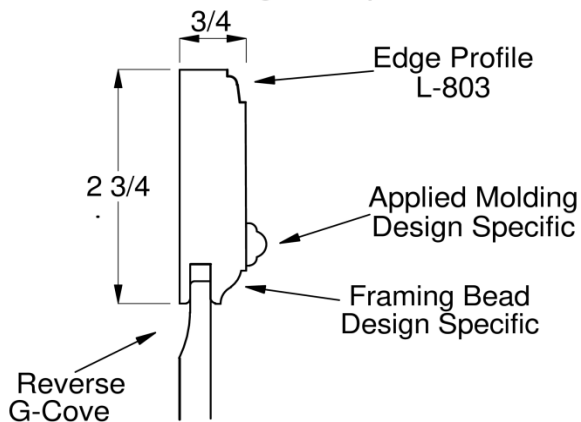

Door Edge Profile and Panel Raise Option

### Churchill

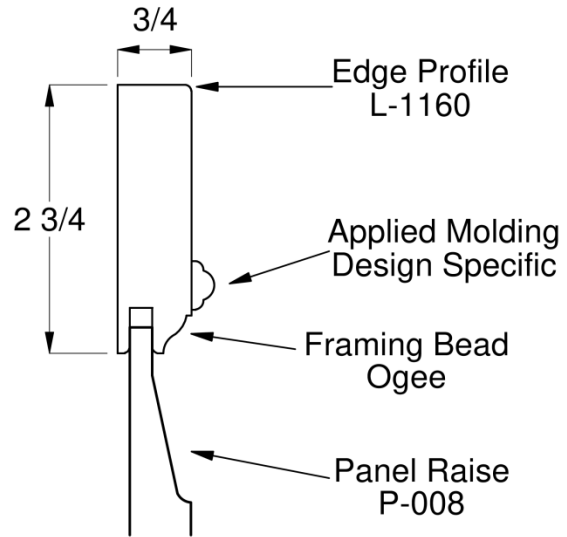
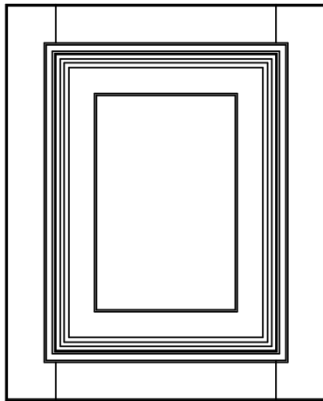

### Slab

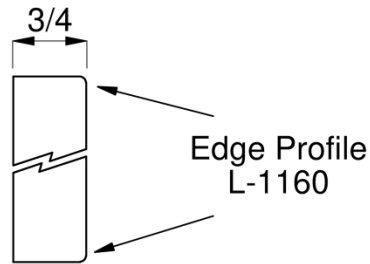
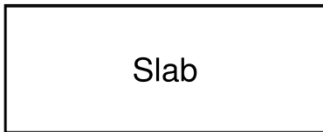

### Small Drawer Front with 2" Rails 'SDF'

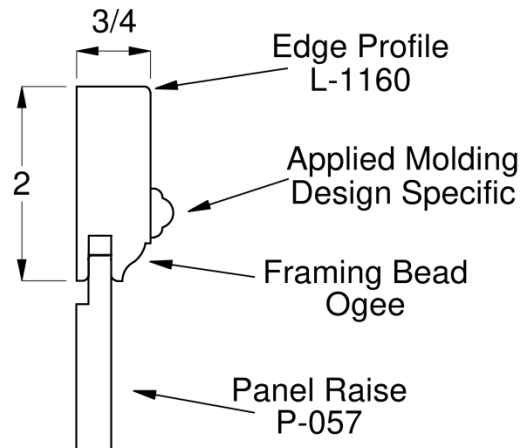
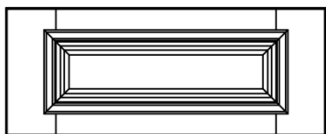

### Large Drawer Front match door framing 'LDF'

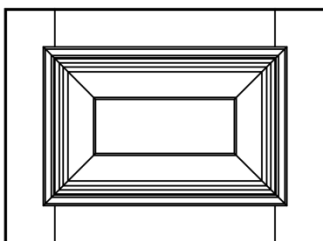

match door framing  
(see door detail above)



## Lasalle Level 6

Framed	Frameless	Plywood	Furniture Board	Plain Inset	Beaded Inset	Full Overlay	Matching Drawer Front	Radius Door	Standard Hood Front	Concealed Hinge	Standard R.P. Arched Valance	Available Painted	Wainscot
				NA	NA				NA		NA		NA

**Notes:**

Available in: alder, cherry, hard maple, standard maple, paint grade, and red oak only.  
Mullions not available.

Minimum Size: 8-5/8"w. x 8-5/8"h.

Section Drawings of options available:

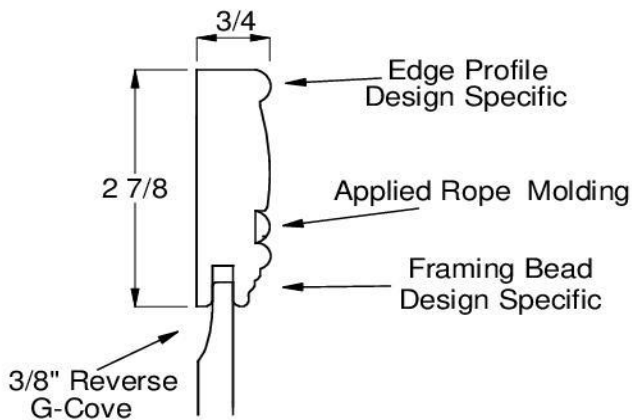

Door Panel Option

MDF Availability		
1 PC	2 PC	5 PC
NA	NA	NA

## Level 6

Lasalle

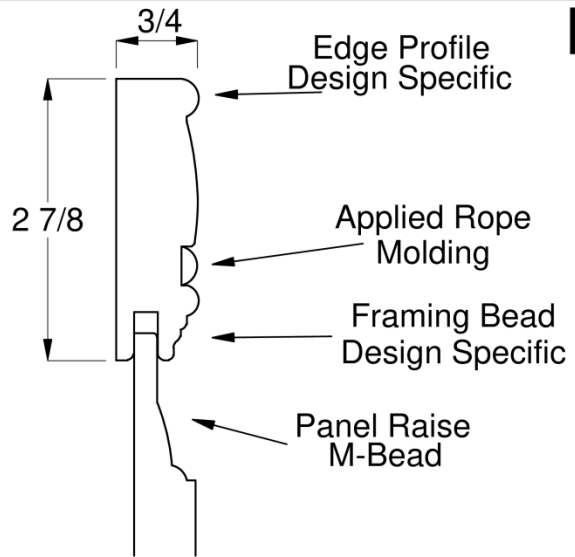
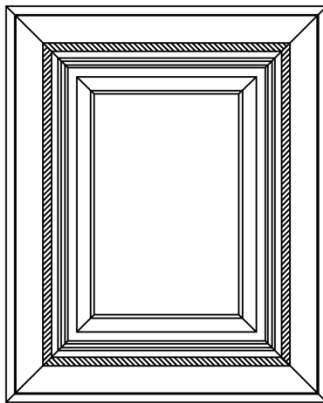

Slab

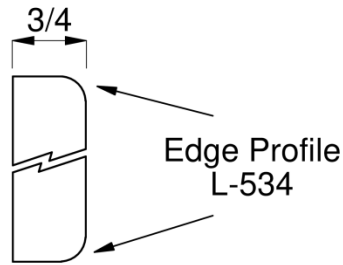
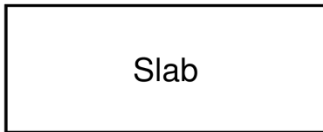

Small Drawer Front with 2" Framing 'SDF'

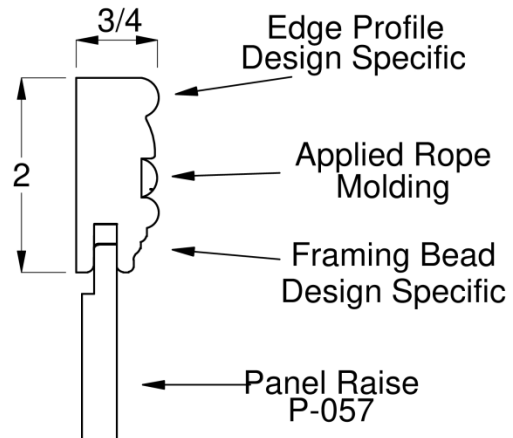

Large Drawer Front match door framing 'LDF'

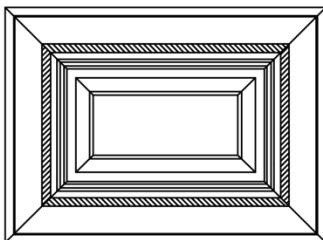

match door framing  
(see door detail above)

## Rosecliff Level 6



Framed	Frameless	Plywood	Furniture Board	Plain Inset	Beaded Inset	Full Overlay	Matching Drawer Front	Radius Door	Standard Hood Front	Concealed Hinge	Standard R.P. Arched Valance	Available Painted	Wainscot
									NA		NA		

Notes:

Not available with mullions.  
 1-1/2" rails on SDF available as custom quote.

Minimum Size: 9-1/4"w x 9-1/4"h

MDF Availability		
1 PC	2 PC	5 PC
NA	NA	NA

Section Drawings of options available:

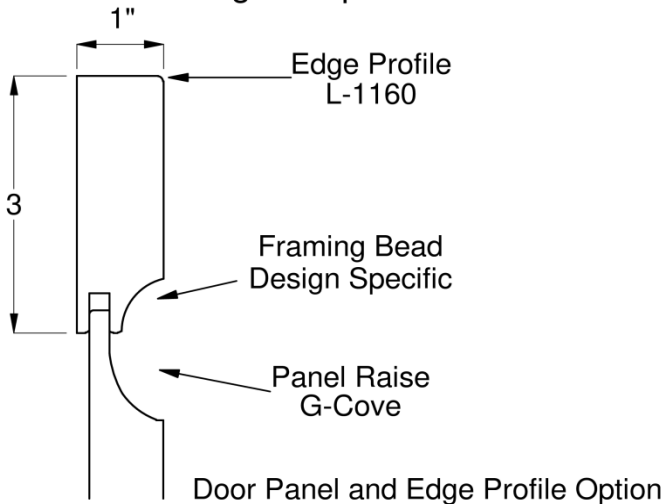



Rosecliff

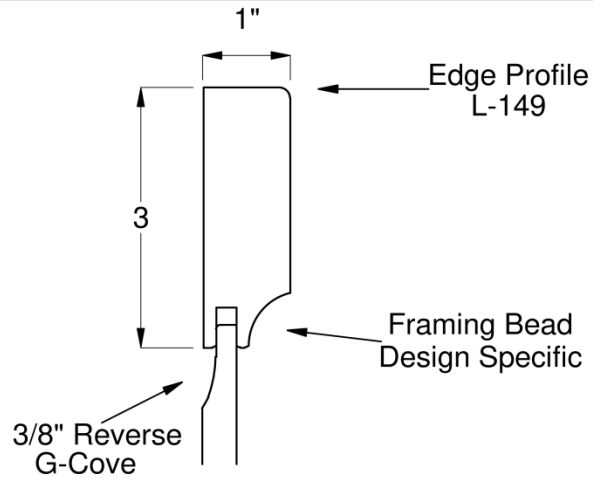
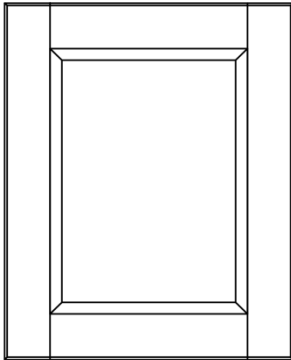

Slab

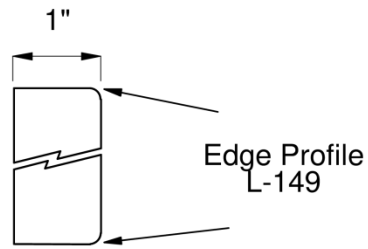
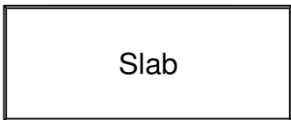

Small Drawer Front with reduced rails 'SDF'

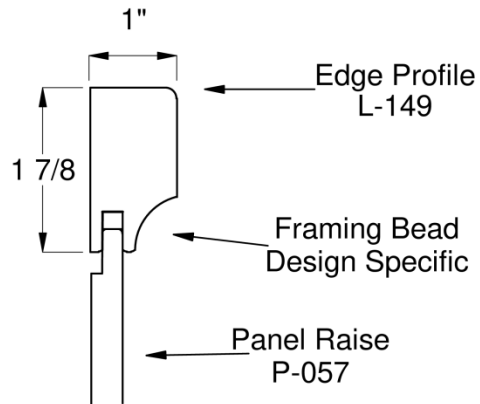
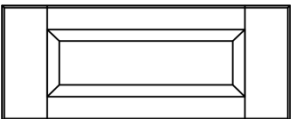

Large Drawer Front match door framing 'LDF'

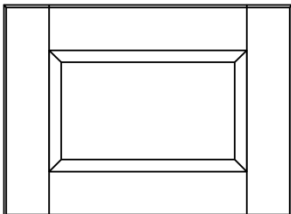

match door framing  
(see door detail above)



## NOTES



# LEVEL 7

## Plymouth Level 7



Framed	Frameless	Plywood	Furniture Board	Plain Inset	Beaded Inset	Full Overlay	Matching Drawer Front	Radius Door	Standard Hood Front	Concealed Hinge	Standard R.P. Arched Valance	Available Painted	Wainscot
									NA		NA		

Notes:

Minimum Size: 7-1/2"w x 7-1/2"h

MDF Availability		
1 PC	2 PC	5 PC

Section Drawings of options available:

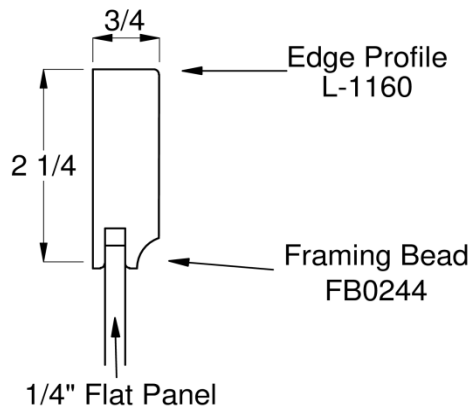
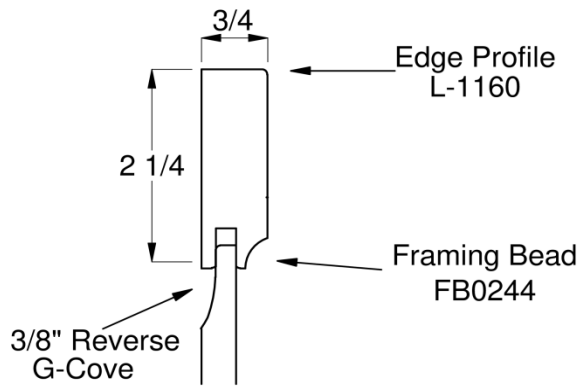

Door Panel Raise Option

## Level 7

Plymouth

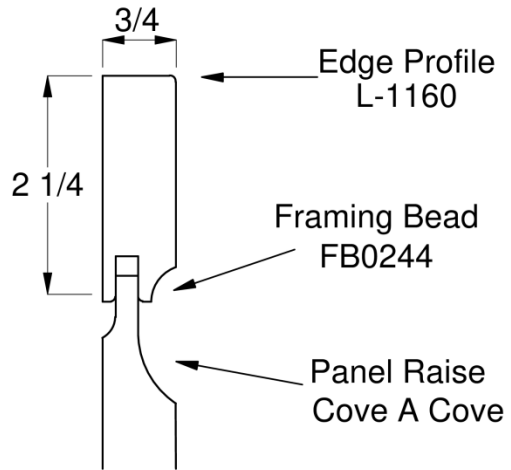
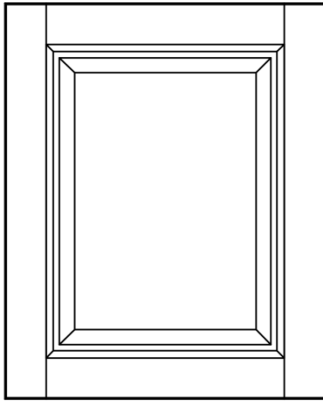

Slab

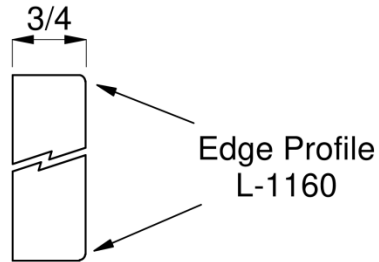
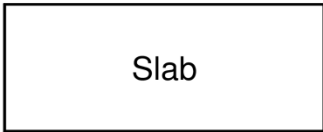

Small Drawer Front with reduced rails 'SDF'

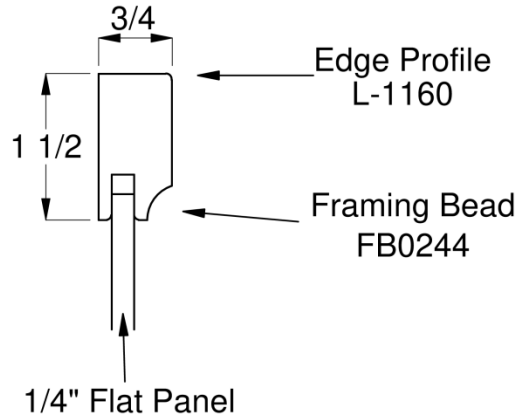
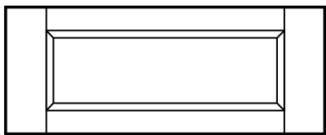

Large Drawer Front match door framing 'LDF'

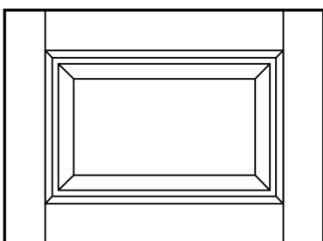

match door framing  
(see door detail above)



## NOTES



# LEVEL 8



## Crossbuck Level 8

Framed	Frameless	Plywood	Furniture Board	Plain Inset	Beaded Inset	Full Overlay	Matching Drawer Front	Radius Door	Standard Hood Front	Concealed Hinge	Standard R.P. Arched Valance	Available Painted	Wainscot
							NA	NA	NA		NA		

Notes:

Mullions not available.

Minimum Size: 8"w x 8"h

Section Drawings of options available:

MDF Availability		
1 PC	2 PC	5 PC
NA	NA	NA



Crossbuck

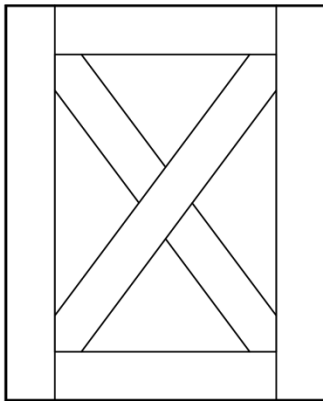

Slab Drawer Front Only  
'SDF' + 'LDF'

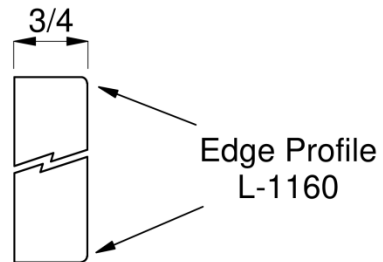
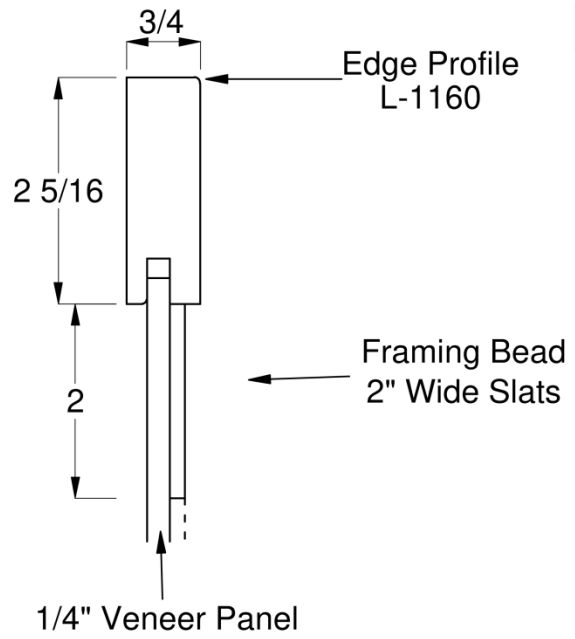
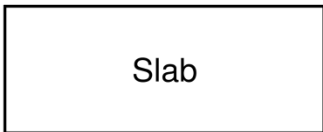



## Key West Level 8

Framed	Frameless	Plywood	Furniture Board	Plain Inset	Beaded Inset	Full Overlay	Matching Drawer Front	Radius Door	Standard Hood Front	Concealed Hinge	Standard R.P. Arched Valance	Available Painted	Wainscot
							NA	NA	NA		NA		

Notes:

Mullions not available.

Minimum Size: 7-1/2 "w x 7-1/2"h

Section Drawings of options available:

MDF Availability		
1 PC	2 PC	5 PC
NA	NA	NA

### Key West

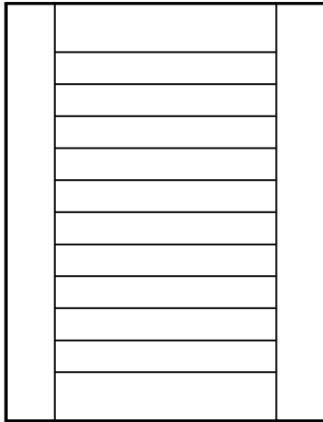

All louvers are same height

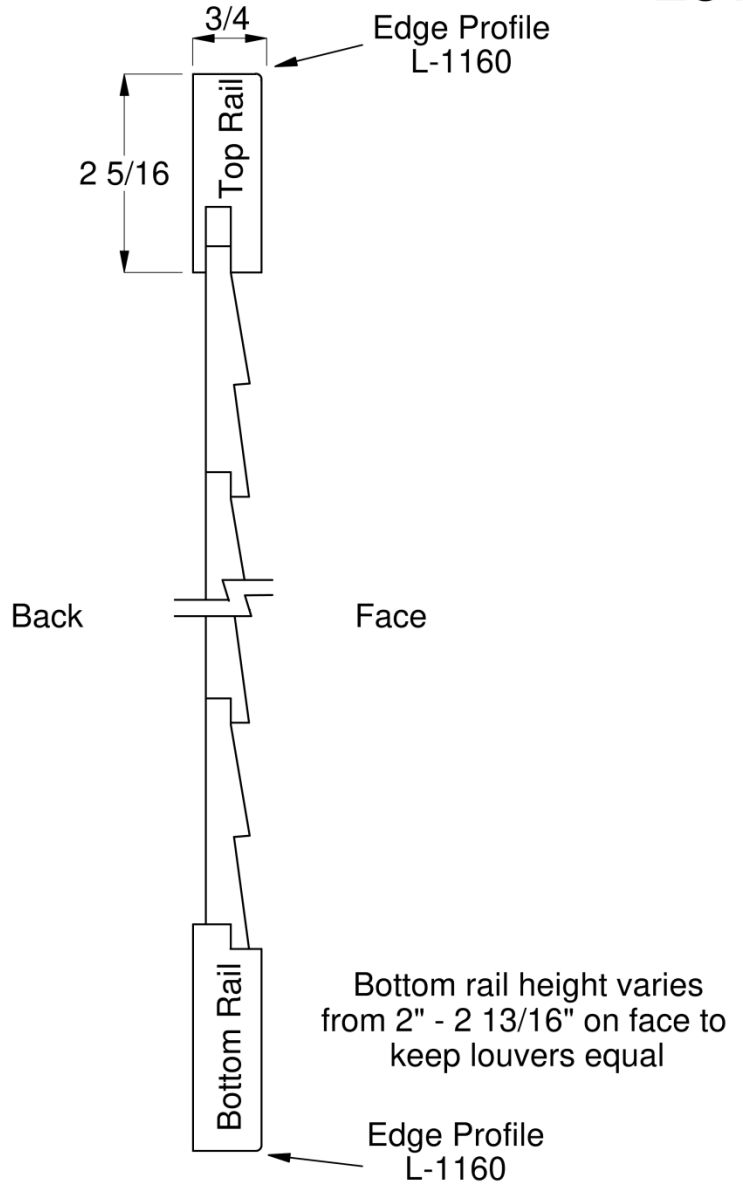

### Slab Drawer Front Only 'SDF' + 'LDF'

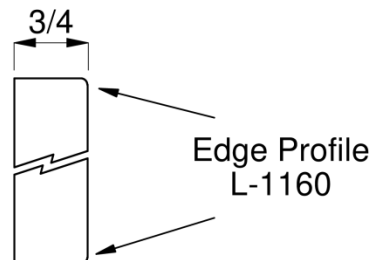
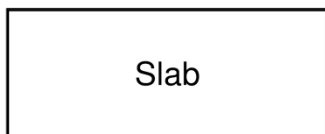



## Nova RE Level 8

Framed	Frameless	Plywood	Furniture Board	Plain Inset	Beaded Inset	Full Overlay	Matching Drawer Front	Radius Door	Standard Hood Front	Concealed Hinge	Standard R.P. Arched Valance	Available Painted	Wainscot
								NA	NA		NA		

Notes:

Square mullions only.

Minimum Size: 9"w x 9"h.

MDF Availability		
1 PC	2 PC	5 PC
NA	NA	NA

Section Drawings of options available:

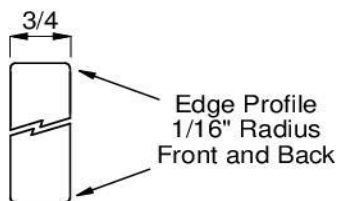
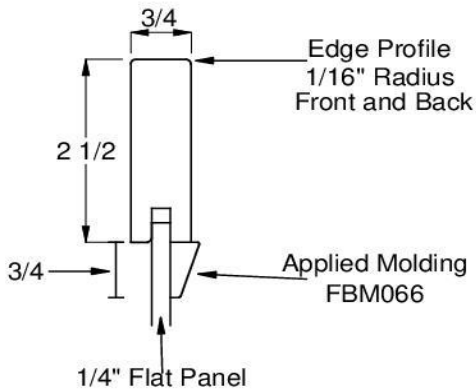

Door Edge Profile Option

Nova RE

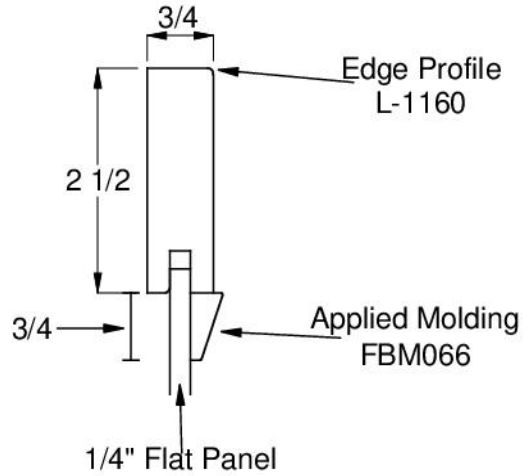
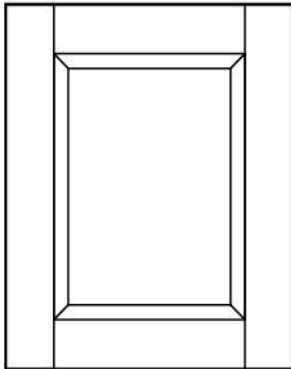

Slab

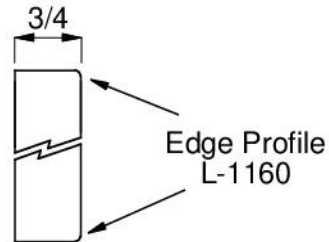
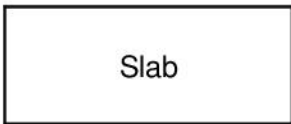

Small Drawer Front with reduced rails 'SDF'

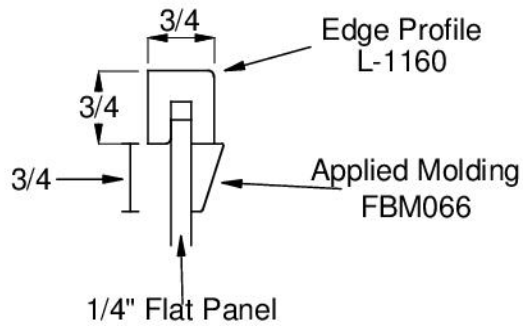
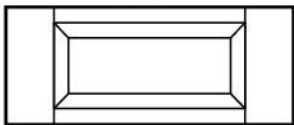

Large Drawer Front match door framing 'LDF'

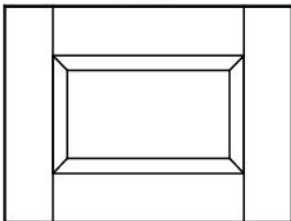

match door framing  
(see door detail above)



## NOTES



# LEVEL 9



## Bahama Level 9

<i>Framed</i>	<i>Frameless</i>	<i>Plywood</i>	<i>Furniture Board</i>	<i>Plain Inset</i>	<i>Beaded Inset</i>	<i>Full Overlay</i>	<i>Matching Drawer Front</i>	<i>Radius Door</i>	<i>Standard Hood Front</i>	<i>Concealed Hinge</i>	<i>Standard R.P. Arched Valance</i>	<i>Available Painted</i>	<i>Wainscot</i>
							NA	NA	NA		NA		

Notes:

The following finish types are not available:  
 paint with glaze  
 heirloom  
 vintage  
 unitone  
 matte stain.

Minimum Size: 7-1/2"w x 7-1/2"h

Section Drawings of options available:

MDF Availability		
1 PC	2 PC	5 PC
NA	NA	NA



### Bahama

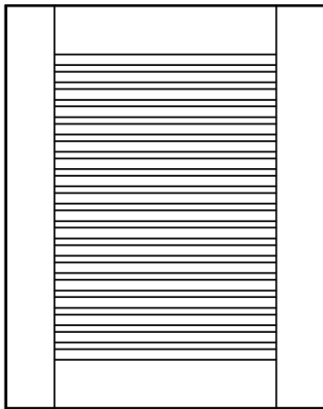

All louvers are same height

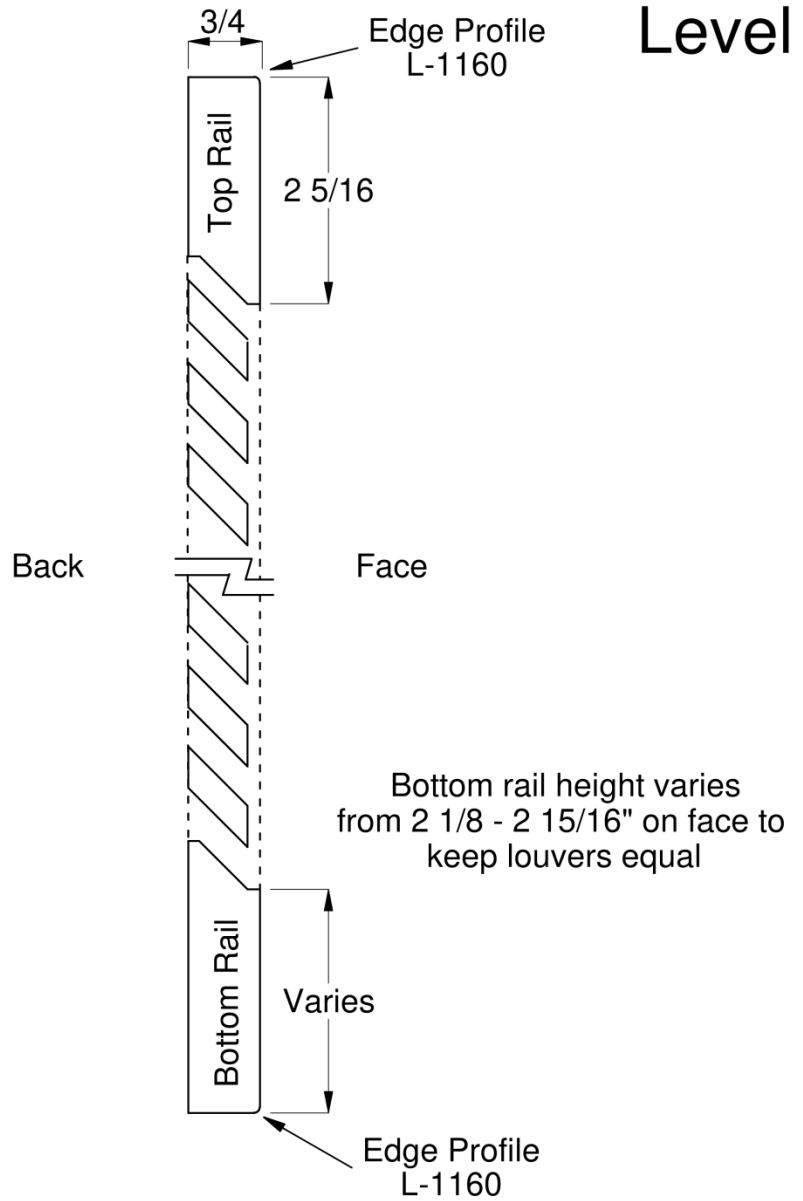

Slab Drawer Front Only  
'SDF' + 'LDF'

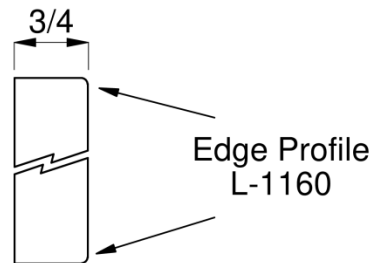
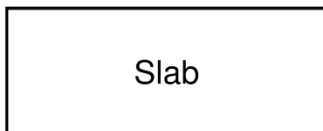



## NOTES



# ALTERNATIVE MATERIALS

**ALLURE** - Decorative Laminate Veneer (DLV)

**ALUMINUM FRAMED DOORS** – Glass or Acrylic inserts

**TTS – Thermally Textured Surface -**

**STRATA** – heavier varied wood grain texture

**VOGUE** – subtle, amazingly lifelike wood grain characteristics

**INTRIGUE** - mild, realistic, registered & indexed wood grain texture

**SYNCHRONICITY** - High gloss acrylic or Super Matte

\*All doors are constructed with an MDF core

<b>Allure</b>		<b>Aluminum Frame Doors</b>	
Avalon	1.156	AF002, AF003, AF007, AF011	1.200
Boca225	1.158		
Boca 300	1.160	<b>Strata</b>	
Cabo 225	1.162	Strata Slab	1.204
Daytona 225	1.164	Strata 3-Piece	1.206
Daytona 300	1.166	Strata 5-Piece	1.208
Delray 225	1.168		
Delray 300	1.170	<b>Vogue</b>	
Melbourne 225	1.172	Vogue Slab	1.212
Melbourne 300	1.174	Vogue 3-Piece	1.214
Montego 225	1.176	Vogue 5-Piece	1.216
Montego 275	1.178		
Rio 225	1.180	<b>Intrigue</b>	
Rio 300	1.182	Intrigue Slab	1.220
Roma 225	1.184	Intrigue 3-Piece	1.222
Roma 300	1.186	Intrigue 5-Piece	1.224
Sorrento 225	1.188		
Sorrento 300	1.190	<b>Synchronicity</b>	
Tobago 225	1.192	Synchronicity – Super Matte Slab	1.228
Veracruz225	1.194	Synchronicity –Mera Slab	1.230
Veracruz275	1.196	Synchronicity – Vetro Slab	1.232



# ALTERNATIVE MATERIALS

## ALLURE



## Alternative Materials Allure - Avalon

Framed	Frameless	Plywood	Furniture Board	Plain Inset	Beaded Inset	Full Overlay	Matching Drawer Front	Radius Door	Standard Hood Front	Concealed Hinge	Standard R.P. Arched Valance	Available Painted	Wainscot
NA		NA		NA	NA			NA	NA		NA	NA	NA

**Notes:**

Not available with mullions.  
Available in: Bright White, White Dove.

Minimum Size: 2-3/4"w x 6-3/8"h

Section Drawings of options available:

## Allure

Allure - Avalon (R)



Drawer Front  
match door framing



match door framing  
(see door detail above)



## Alternative Materials Allure - Boca225

Framed	Frameless	Plywood	Furniture Board	Plain Inset	Beaded Inset	Full Overlay	Matching Drawer Front	Radius Door	Standard Hood Front	Concealed Hinge	Standard R.P. Arched Valance	Available Painted	Wainscot
NA		NA		NA	NA			NA	NA		NA	NA	NA

**Notes:**

Not available with mullions.  
 Panel recess is 3/8" from face of frame.  
 Available in: Ashen Grey, Canadian Grey, Concrete Groovz, Monaco, White Chocolate, Silva, Skye.

Minimum Size: 7"w x 7"h

Section Drawings of options available:



Boca225

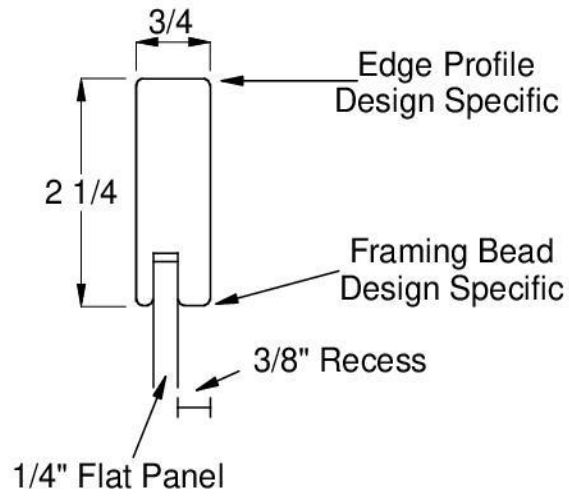
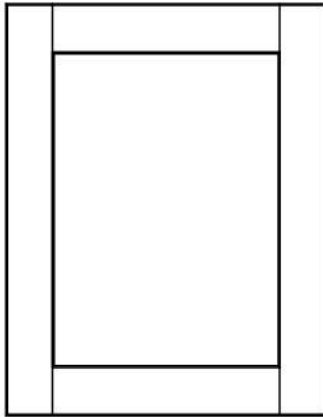

Drawer Front  
match door framing

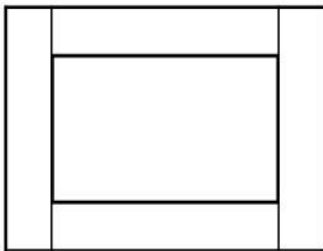

match door framing  
(see door detail above)



## Alternative Materials Allure - Boca300

Framed	Frameless	Plywood	Furniture Board	Plain Inset	Beaded Inset	Full Overlay	Matching Drawer Front	Radius Door	Standard Hood Front	Concealed Hinge	Standard R.P. Arched Valance	Available Painted	Wainscot
NA		NA		NA	NA			NA	NA		NA	NA	NA

Notes:

- Not available with mullions.
- Panel recess is 3/8" from face of frame.
- Available in: Ashen Grey, Canadian Grey, Concrete Groovz, Monaco, White Chocolate, Silva, Skye.

Minimum Size: 8-1/2"w x 7"h

Section Drawings of options available:

Boca300

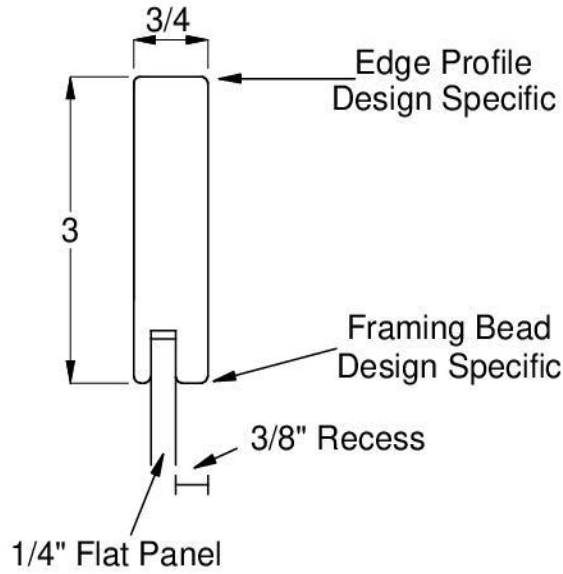
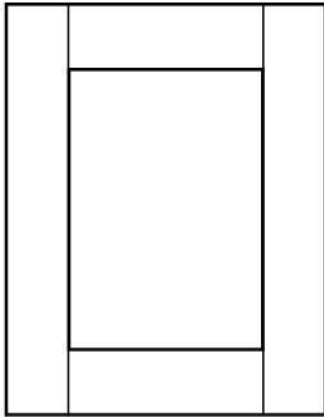

Drawer Front reduced rails

Boca330

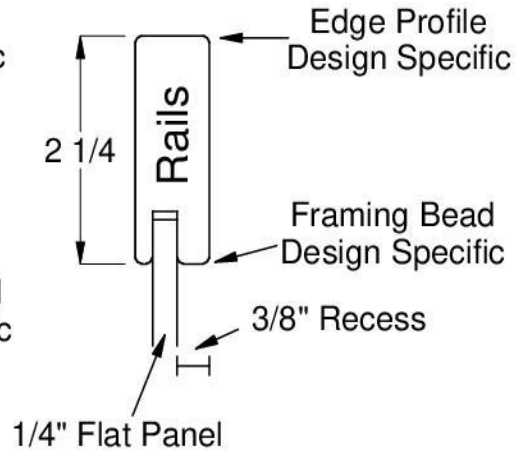
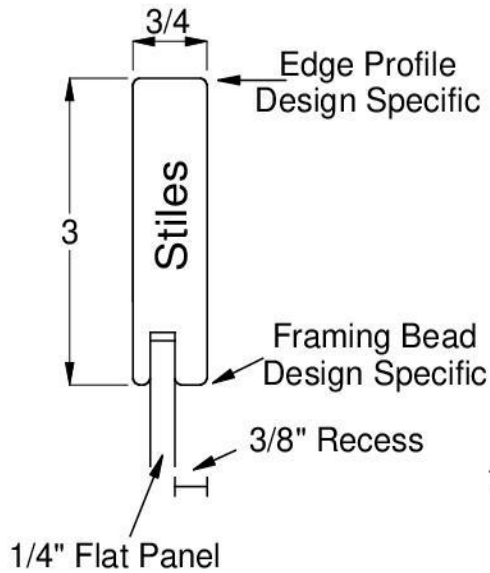
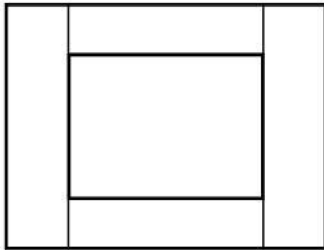

Drawer Front match door framing

Boca300

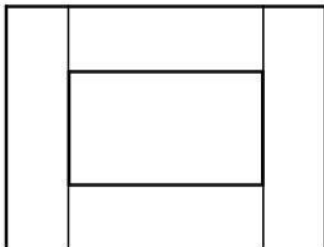

match door framing  
(see door detail above)



## Alternative Materials Allure - Cabo225

Framed	Frameless	Plywood	Furniture Board	Plain Inset	Beaded Inset	Full Overlay	Matching Drawer Front	Radius Door	Standard Hood Front	Concealed Hinge	Standard R.P. Arched Valance	Available Painted	Wainscot
NA		NA		NA	NA			NA	NA		NA	NA	NA

Notes:

Not available with mullions.  
 Panel recess is 3/8" from face of frame.  
 Available in: Bright White, White Dove.

Minimum Size: 7"w x 7"h

Section Drawings of options available:

Cabo225

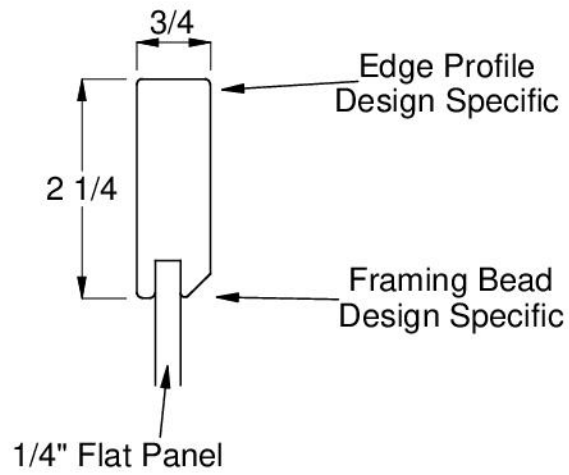
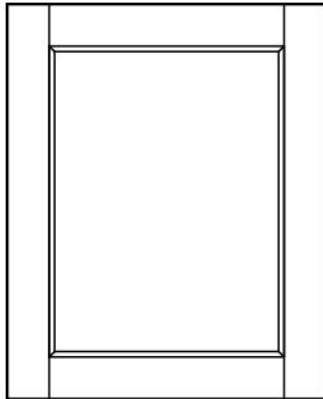

Drawer Front  
match door framing

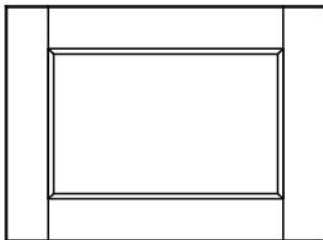

match door framing  
(see door detail above)



## Alternative Materials Allure - Daytona225

Framed	Frameless	Plywood	Furniture Board	Plain Inset	Beaded Inset	Full Overlay	Matching Drawer Front	Radius Door	Standard Hood Front	Concealed Hinge	Standard R.P. Arched Valance	Available Painted	Wainscot
NA		NA		NA	NA			NA	NA		NA	NA	NA

**Notes:**

Not available with mullions.  
 Panel recess is 1/4" from face of frame.  
 Available in: Bright White, White Dove.

Minimum Size: 6-1/2"w x 7"h

Section Drawings of options available:

Daytona225

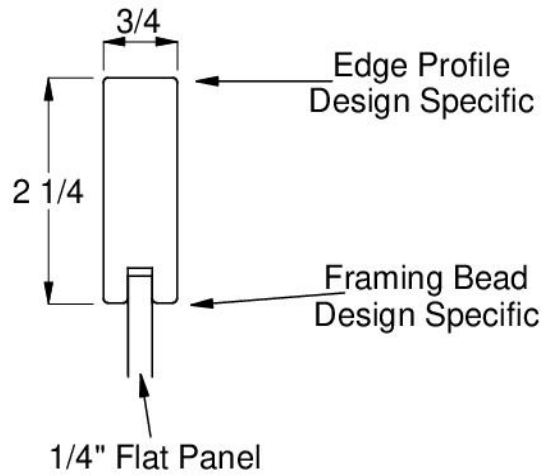
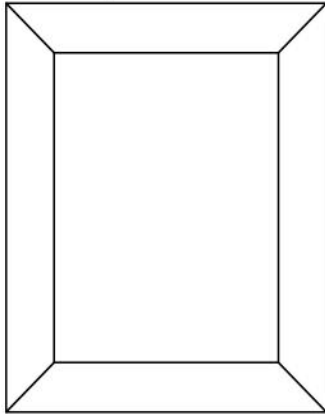

Drawer Front  
match door framing

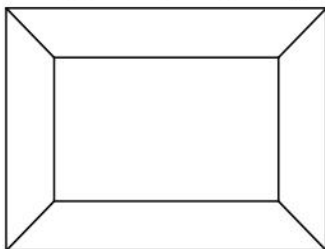

match door framing  
(see door detail above)



## Alternative Materials Allure - Daytona300

Framed	Frameless	Plywood	Furniture Board	Plain Inset	Beaded Inset	Full Overlay	Matching Drawer Front	Radius Door	Standard Hood Front	Concealed Hinge	Standard R.P. Arched Valance	Available Painted	Wainscot
NA		NA		NA	NA			NA	NA		NA	NA	NA

Notes:

- Not available with mullions.
- Panel recess is 1/4" from face of frame.
- Available in: Bright White, White Dove.

Minimum Size: 7"w x 8"h

Section Drawings of options available:



Daytona300

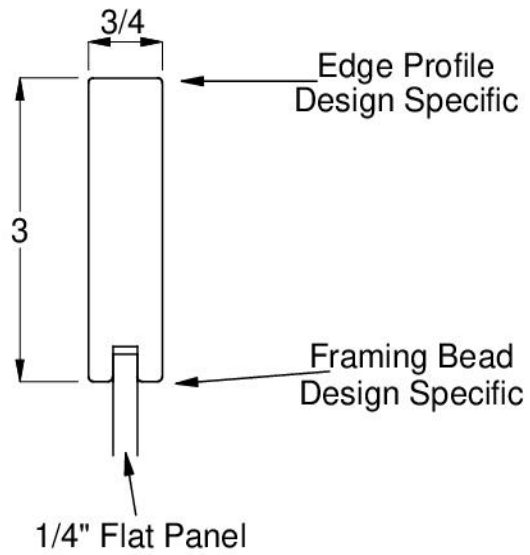
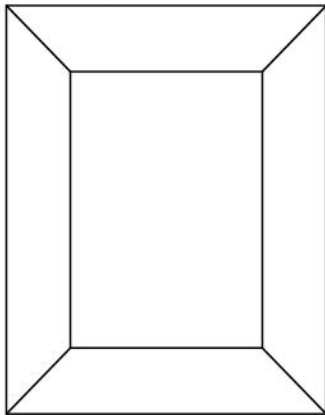

Drawer Front  
match door framing

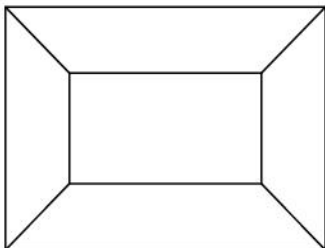

match door framing  
(see door detail above)



## Alternative Materials Allure - Delray225

Framed	Frameless	Plywood	Furniture Board	Plain Inset	Beaded Inset	Full Overlay	Matching Drawer Front	Radius Door	Standard Hood Front	Concealed Hinge	Standard R.P. Arched Valance	Available Painted	Wainscot
NA		NA		NA	NA			NA	NA		NA	NA	NA

**Notes:**

Not available with mullions.  
 Panel recess is 1/4" from face of frame.  
 Available in: Bright White, White Dove.

Minimum Size: 7"w x 7"h

Section Drawings of options available:

Delray225

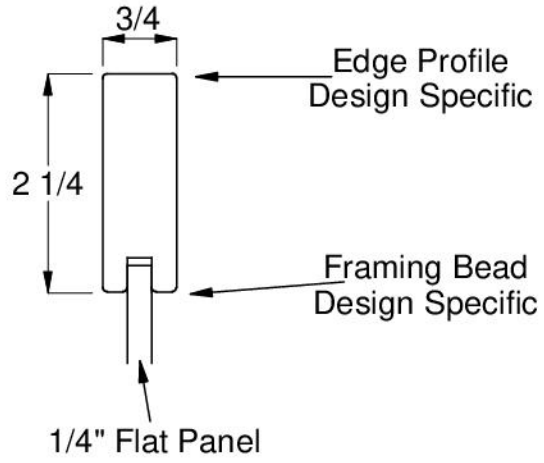
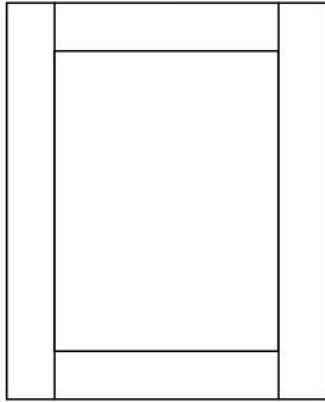

Drawer Front  
match door framing

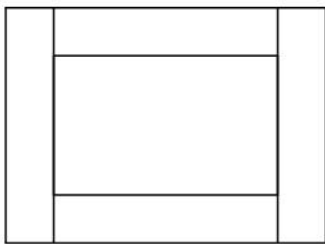

match door framing  
(see door detail above)



## Alternative Materials Allure - Delray300

Framed	Frameless	Plywood	Furniture Board	Plain Inset	Beaded Inset	Full Overlay	Matching Drawer Front	Radius Door	Standard Hood Front	Concealed Hinge	Standard R.P. Arched Valance	Available Painted	Wainscot
NA		NA		NA	NA			NA	NA		NA	NA	NA

**Notes:**

Not available with mullions.  
 Panel recess is 1/4" from face of frame.  
 Available in: Bright White, White Dove.

Minimum Size: 8-1/2"w x 7"h

Section Drawings of options available:

Delray300

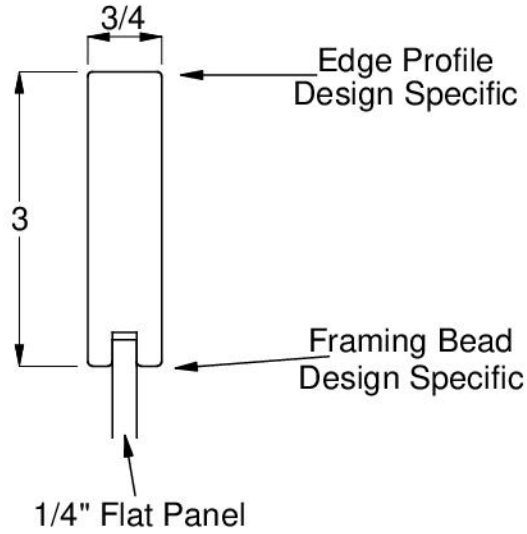
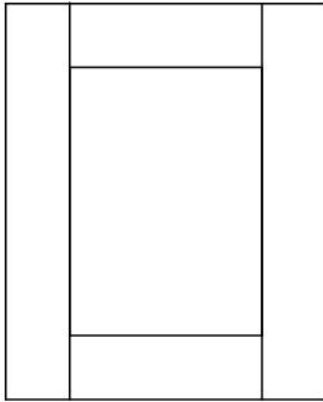

Drawer Front  
reduced rails  
Delray330

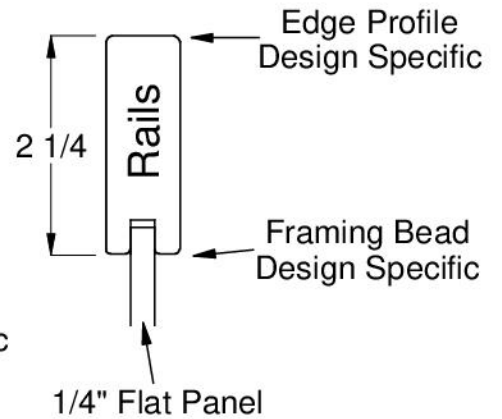
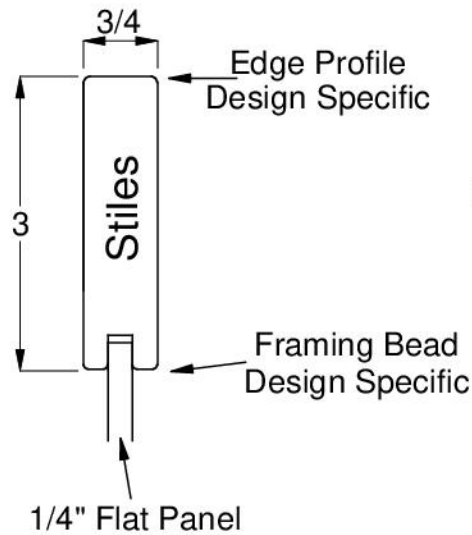
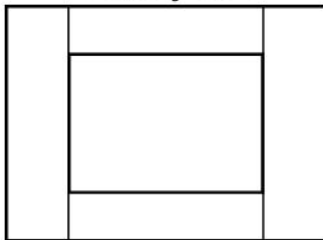

Drawer Front  
match door framing  
Delray300

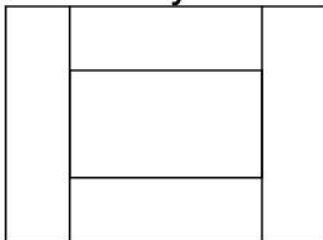

match door framing  
(see door detail above)



## Alternative Materials Allure - Melbourne225

Framed	Frameless	Plywood	Furniture Board	Plain Inset	Beaded Inset	Full Overlay	Matching Drawer Front	Radius Door	Standard Hood Front	Concealed Hinge	Standard R.P. Arched Valance	Available Painted	Wainscot
NA		NA		NA	NA			NA	NA		NA	NA	NA

**Notes:**

Not available with mullions.  
 Panel recess is 1/8" from face of frame.  
 Available in: Ashen Grey, Canadian Grey, Concrete Groovz, Monaco, White Chocolate, Silva, Skye

Minimum Size: 7"w x 7"h

Section Drawings of options available:

Melbourne225

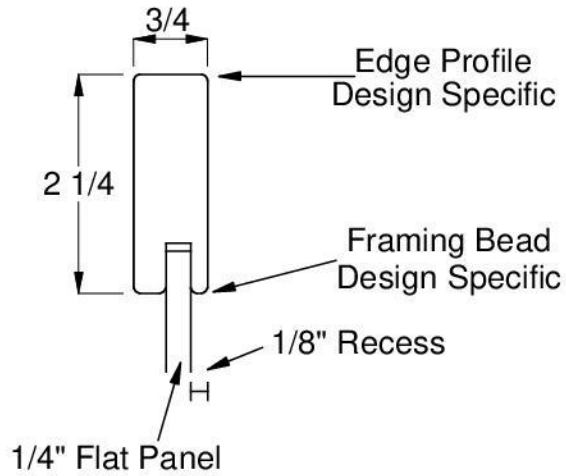
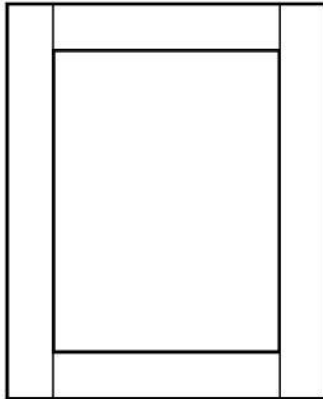

Drawer Front  
match door framing

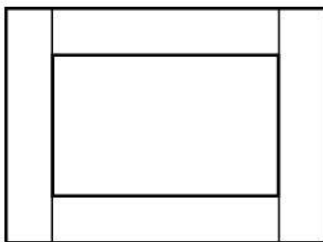

match door framing  
(see door detail above)



## Alternative Materials Allure - Melbourne300

Framed	Frameless	Plywood	Furniture Board	Plain Inset	Beaded Inset	Full Overlay	Matching Drawer Front	Radius Door	Standard Hood Front	Concealed Hinge	Standard R.P. Arched Valance	Available Painted	Wainscot
NA		NA		NA	NA			NA	NA		NA	NA	NA

Notes:

Not available with mullions.  
 Panel recess is 1/8" from face of frame.  
 Available in: Ashen Grey, Canadian Grey, Concrete Groovz, Monaco, White Chocolate, Silva, Skye

Minimum Size: 8-1/2"w x 7"h

Section Drawings of options available:





## Allure

Melbourne300

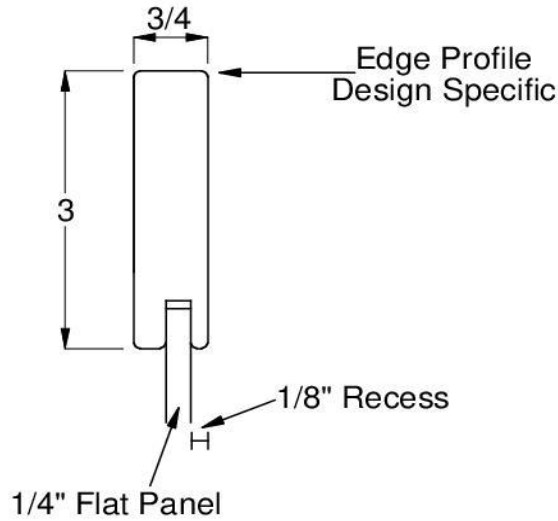
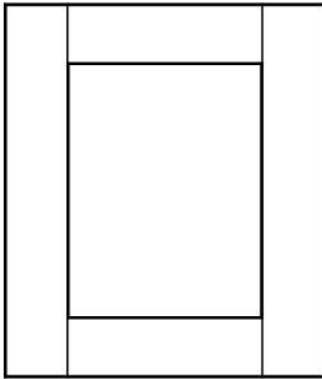

Drawer Front reduced rails

Melbourne330

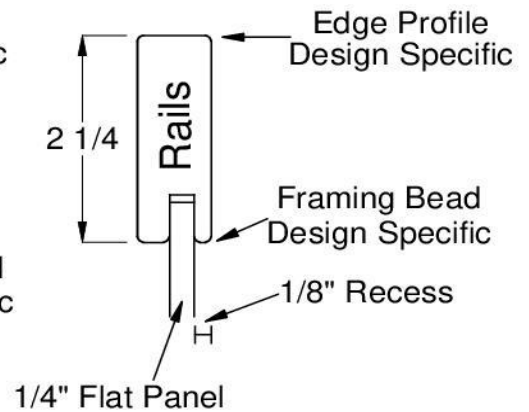
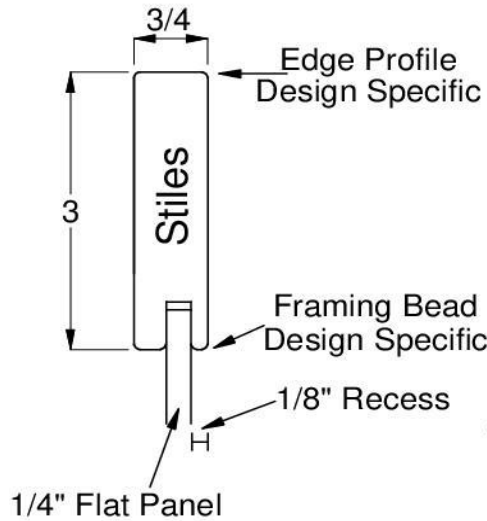
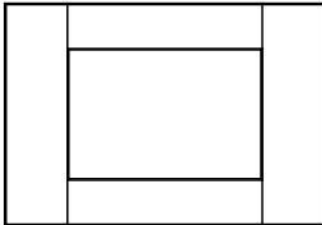

Drawer Front match door framing  
Melbourne300

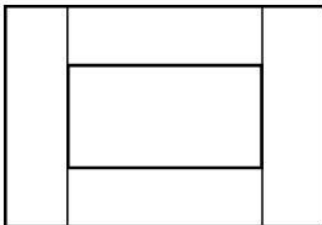

match door framing  
(see door detail above)



## Alternative Materials Allure - Montego225

Framed	Frameless	Plywood	Furniture Board	Plain Inset	Beaded Inset	Full Overlay	Matching Drawer Front	Radius Door	Standard Hood Front	Concealed Hinge	Standard R.P. Arched Valance	Available Painted	Wainscot
NA		NA		NA	NA			NA	NA		NA	NA	NA

**Notes:**

Not available with mullions.  
 Panel recess is 3/8" from face of frame.  
 Available in: Ashen Grey, Canadian Grey, Concrete Groovz, Monaco, White Chocolate, Silva, Skye.

Minimum Size: 6-1/2"w x 7"h

Section Drawings of options available:

Montego225

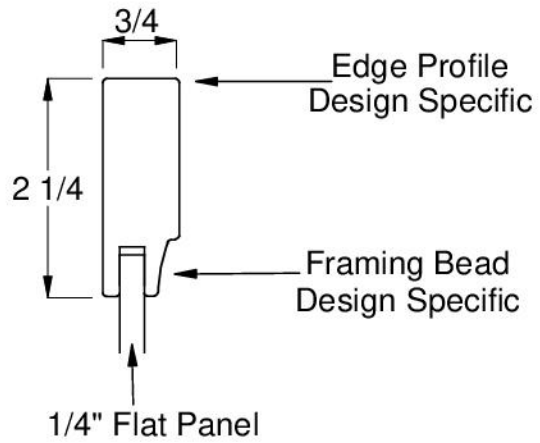
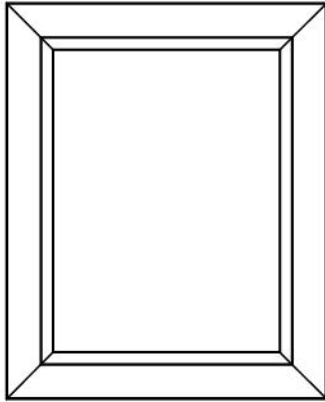

Drawer Front  
match door framing

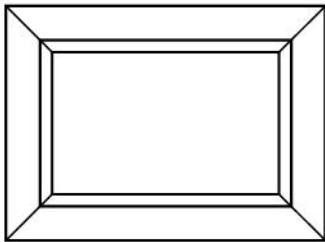

match door framing  
(see door detail above)



## Alternative Materials Allure - Montego275

Framed	Frameless	Plywood	Furniture Board	Plain Inset	Beaded Inset	Full Overlay	Matching Drawer Front	Radius Door	Standard Hood Front	Concealed Hinge	Standard R.P. Arched Valance	Available Painted	Wainscot
NA		NA		NA	NA			NA	NA		NA	NA	NA

**Notes:**

Not available with mullions.  
 Panel recess is 3/8" from face of frame.  
 Available in: Ashen Grey, Canadian Grey, Concrete Groovz, Monaco, White Chocolate, Silva, Skye.

Minimum Size: 6-1/2"w x 7"h

Section Drawings of options available:

Montego275

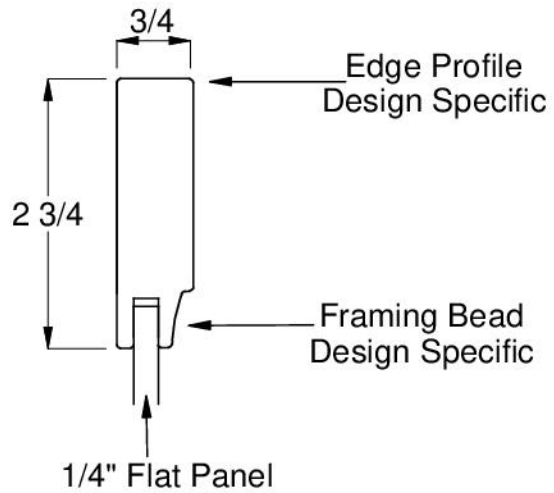
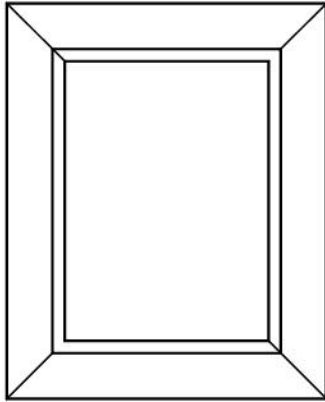

Drawer Front  
match door framing

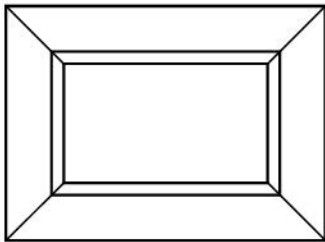

match door framing  
(see door detail above)



## Alternative Materials Allure - Rio225

Framed	Frameless	Plywood	Furniture Board	Plain Inset	Beaded Inset	Full Overlay	Matching Drawer Front	Radius Door	Standard Hood Front	Concealed Hinge	Standard R.P. Arched Valance	Available Painted	Wainscot
NA		NA		NA	NA			NA	NA		NA	NA	NA

**Notes:**

Not available with mullions.  
 Panel recess is 3/8" from face of frame.  
 Available in: Ashen Grey, Canadian Grey, Concrete Groovz, Monaco, White Chocolate, Silva, Skye.

Minimum Size: 6-1/2"w x 7"h

Section Drawings of options available:



## Allure

Rio225

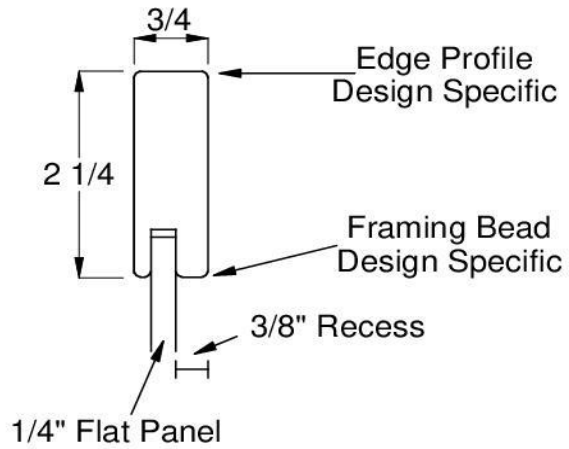
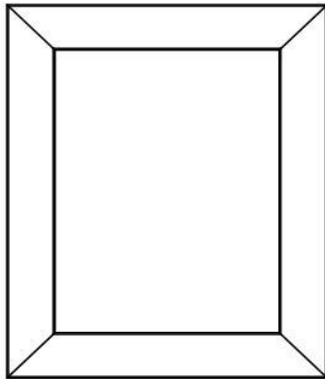

Drawer Front  
match door framing

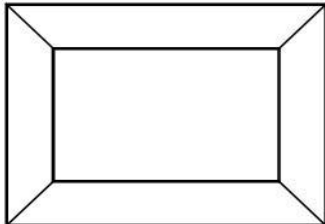

match door framing  
(see door detail above)



## Alternative Materials Allure - Rio300

Framed	Frameless	Plywood	Furniture Board	Plain Inset	Beaded Inset	Full Overlay	Matching Drawer Front	Radius Door	Standard Hood Front	Concealed Hinge	Standard R.P. Arched Valance	Available Painted	Wainscot
NA		NA		NA	NA			NA	NA		NA	NA	NA

**Notes:**

Not available with mullions.  
 Panel recess is 3/8" from face of frame.  
 Available in: Ashen Grey, Canadian Grey, Concrete Groovz, Monaco, White Chocolate, Silva, Skye.

Minimum Size: 7"w x 8"h

Section Drawings of options available:



Rio300

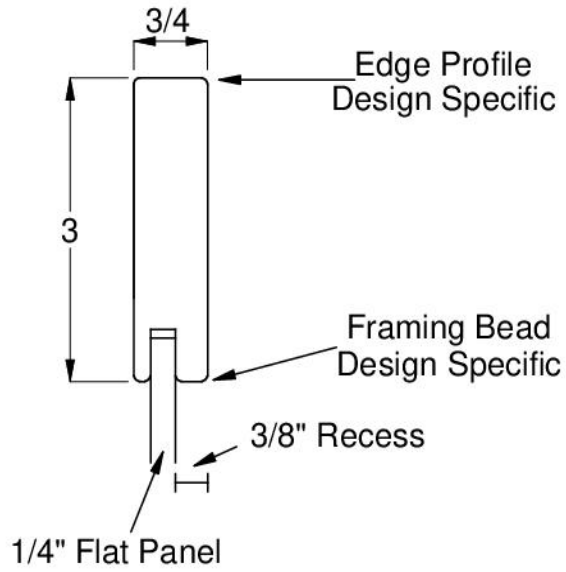
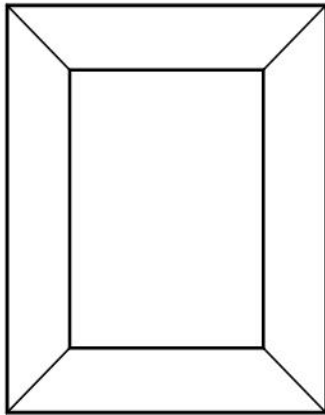

Drawer Front  
match door framing

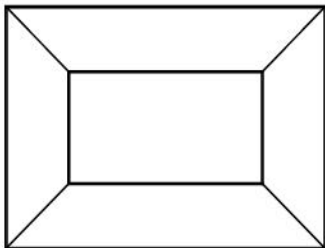

match door framing  
(see door detail above)



## Alternative Materials Allure - Roma225

Framed	Frameless	Plywood	Furniture Board	Plain Inset	Beaded Inset	Full Overlay	Matching Drawer Front	Radius Door	Standard Hood Front	Concealed Hinge	Standard R.P. Arched Valance	Available Painted	Wainscot
NA		NA		NA	NA			NA	NA		NA	NA	NA

**Notes:**

Not available with mullions.  
 Panel recess is 1/8" from face of frame.  
 Available in: Ashen Grey, Canadian Grey, Concrete Groovz, Monaco, White Chocolate, Silva, Skye.

Minimum Size: 6-1/2"w x 7"h

Section Drawings of options available:

Roma225

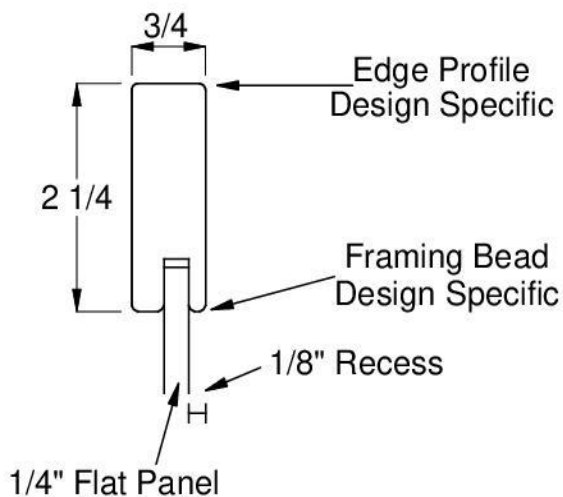
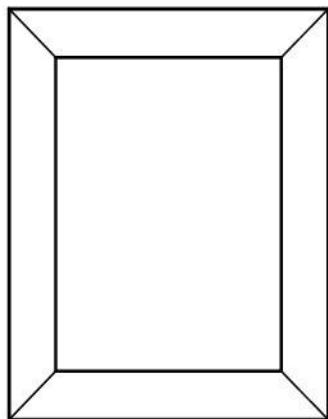

Drawer Front  
match door framing

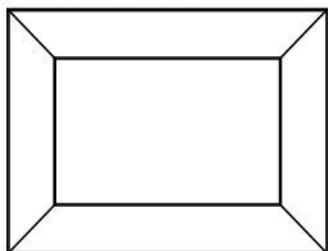

match door framing  
(see door detail above)



## Alternative Materials Allure - Roma300

Framed	Frameless	Plywood	Furniture Board	Plain Inset	Beaded Inset	Full Overlay	Matching Drawer Front	Radius Door	Standard Hood Front	Concealed Hinge	Standard R.P. Arched Valance	Available Painted	Wainscot
NA		NA		NA	NA			NA	NA		NA	NA	NA

**Notes:**

Not available with mullions.  
 Panel recess is 1/8" from face of frame.  
 Available in: Ashen Grey, Canadian Grey, Concrete Groovz, Monaco, White Chocolate, Silva, Skye.

Minimum Size: 7"w x 8"h

Section Drawings of options available:

Roma300

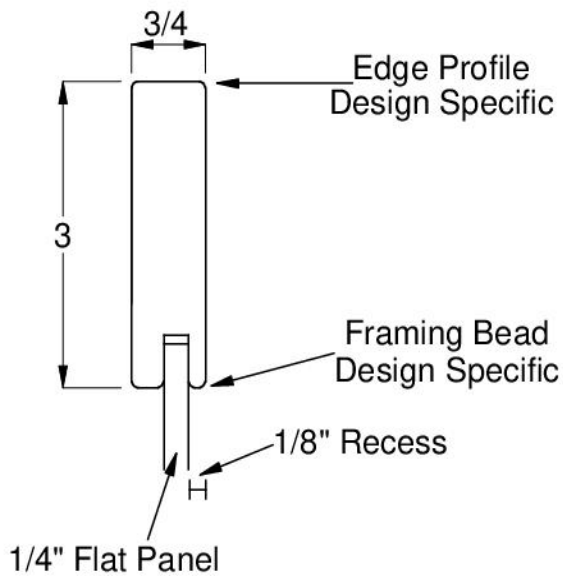
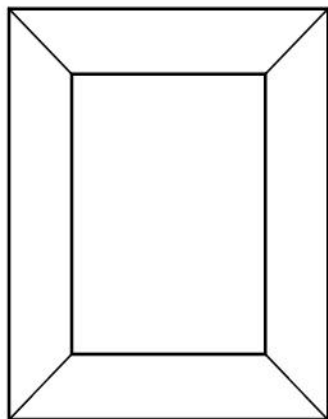

Drawer Front  
match door framing

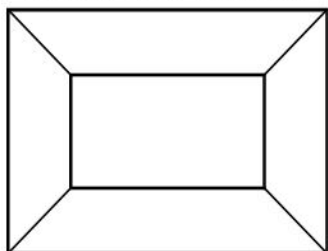

match door framing  
(see door detail above)



## Alternative Materials Allure - Sorrento225

Framed	Frameless	Plywood	Furniture Board	Plain Inset	Beaded Inset	Full Overlay	Matching Drawer Front	Radius Door	Standard Hood Front	Concealed Hinge	Standard R.P. Arched Valance	Available Painted	Wainscot
NA		NA		NA	NA			NA	NA		NA	NA	NA

Notes:

- Not available with mullions.
- Panel recess is 3/8" from face of frame.
- Available in: White Dove.

Minimum Size: 6-1/2"w x 7"h

Section Drawings of options available:

Sorrento225

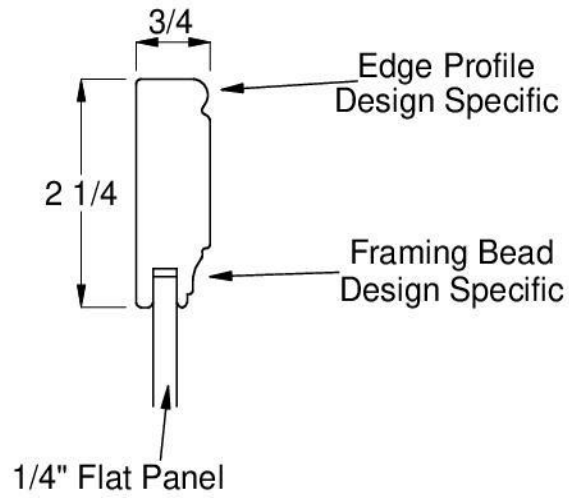
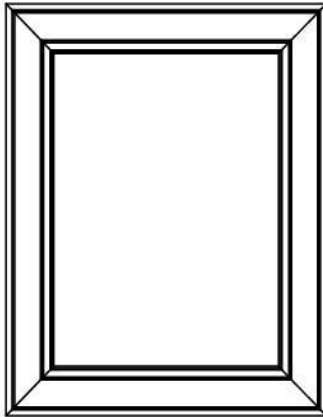

Drawer Front  
match door framing

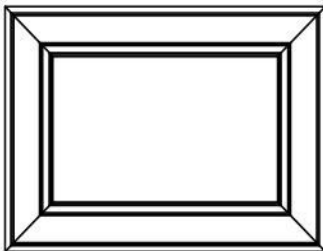

match door framing  
(see door detail above)



## Alternative Materials Allure - Sorrento300

Framed	Frameless	Plywood	Furniture Board	Plain Inset	Beaded Inset	Full Overlay	Matching Drawer Front	Radius Door	Standard Hood Front	Concealed Hinge	Standard R.P. Arched Valance	Available Painted	Wainscot
NA		NA		NA	NA			NA	NA		NA	NA	NA

**Notes:**

Not available with mullions.  
 Panel recess is 3/8" from face of frame.  
 Available in: White Dove.

Minimum Size: 7"w x 8"h

Section Drawings of options available:





## Allure

Sorrento300

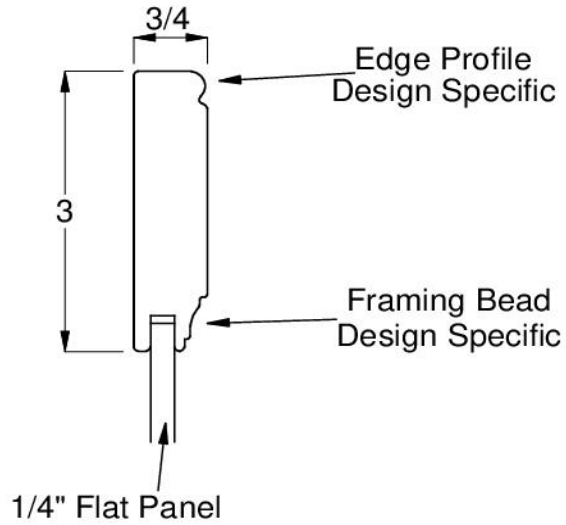
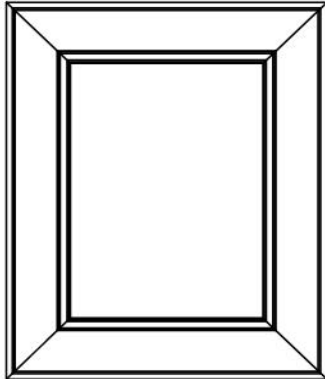

Drawer Front  
match door framing

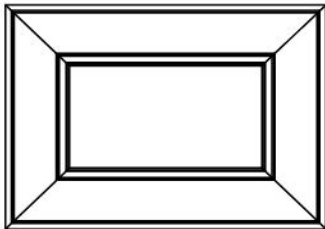

match door framing  
(see door detail above)



## Alternative Materials Allure - Tobago225

Framed	Frameless	Plywood	Furniture Board	Plain Inset	Beaded Inset	Full Overlay	Matching Drawer Front	Radius Door	Standard Hood Front	Concealed Hinge	Standard R.P. Arched Valance	Available Painted	Wainscot
NA		NA		NA	NA			NA	NA		NA	NA	NA

**Notes:**

Not available with mullions.  
 Panel recess is 3/8" from face of frame.  
 Available in: Bright White, White Dove.

Minimum Size: 6-1/2"w x 7"h

Section Drawings of options available:



## Allure

Tobago225

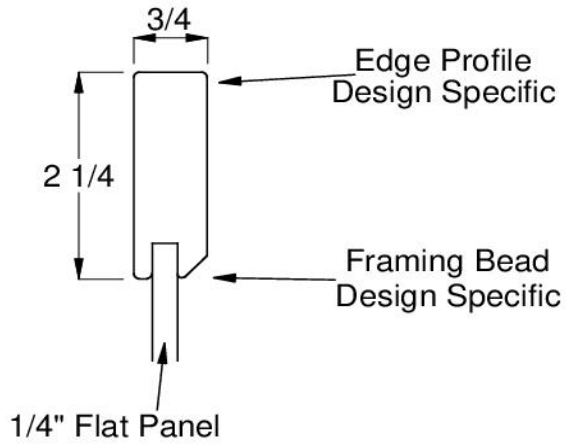
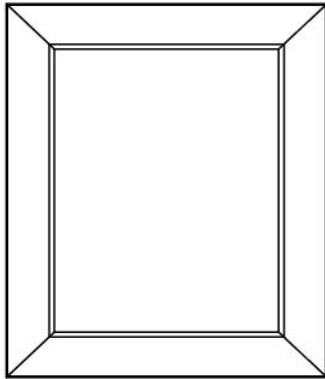

Drawer Front  
match door framing

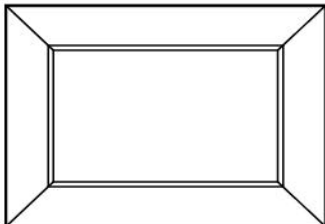

match door framing  
(see door detail above)



## Alternative Materials Allure - Veracruz225

Framed	Frameless	Plywood	Furniture Board	Plain Inset	Beaded Inset	Full Overlay	Matching Drawer Front	Radius Door	Standard Hood Front	Concealed Hinge	Standard R.P. Arched Valance	Available Painted	Wainscot
NA		NA		NA	NA			NA	NA		NA	NA	NA

**Notes:**

Not available with mullions.  
 Panel recess is 3/8" from face of frame.  
 Available in: Bright White.

Minimum Size: 6-1/2"w x 7"h

Section Drawings of options available:



## Allure

Veracruz225

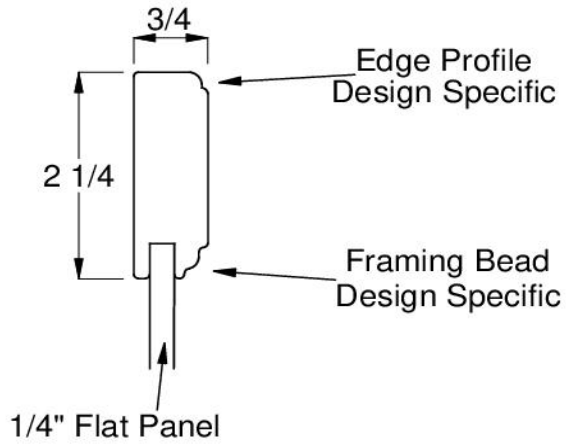
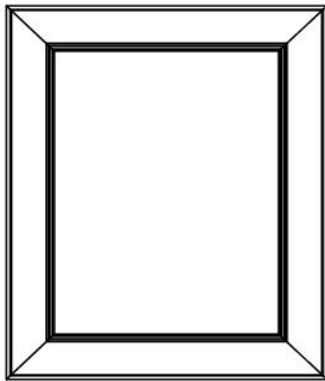

Drawer Front  
match door framing

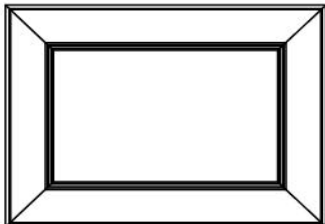

match door framing  
(see door detail above)



## Alternative Materials Allure - Veracruz275

Framed	Frameless	Plywood	Furniture Board	Plain Inset	Beaded Inset	Full Overlay	Matching Drawer Front	Radius Door	Standard Hood Front	Concealed Hinge	Standard R.P. Arched Valance	Available Painted	Wainscot
NA		NA		NA	NA			NA	NA		NA	NA	NA

**Notes:**

Not available with mullions.  
 Panel recess is 3/8" from face of frame.  
 Available in: Bright White.

Minimum Size: 6-1/2"w x 7"h

Section Drawings of options available:



## Allure

Veracruz275

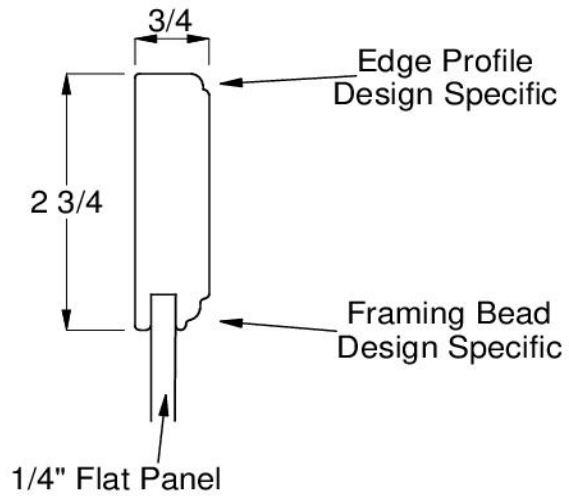
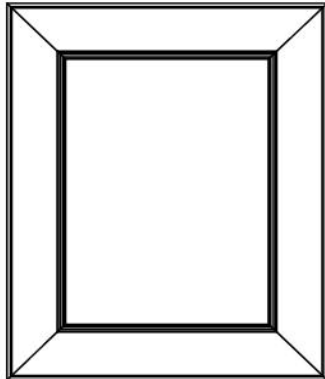

Drawer Front  
match door framing

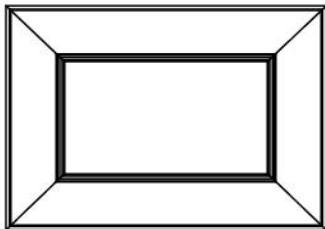

match door framing  
(see door detail above)



## Allure Color Availability Chart

		Smooth Painted look				Woodgrain Texture				
		Bright White	White Dove	Canadian Grey	Ashen Grey	Concrete Groovz	Monaco	White Chocolate	Silva	Skye
Mitered Construction	Daytona 225	x	x							
	Daytona 300	x	x							
	Montego 225			x	x	x	x	x	x	x
	Montego 275			x	x	x	x	x	x	x
	Rio 225			x	x	x	x	x	x	x
	Rio 300			x	x	x	x	x	x	x
	Roma 225			x	x	x	x	x	x	x
	Roma 300			x	x	x	x	x	x	x
	Sorrento 225		x							
	Sorrento 300		x							
	Tobago 225	x	x							
	Veracruz 225	x								
	Veracruz 275	x								
Slab										
	Avalon	x	x							
M&T Construction	Boca 225			x	x	x	x	x	x	x
	Boca 300			x	x	x	x	x	x	x
	Cabo 225	x	x							
	Delray 225	x	x							
	Delray 300	x	x							x
	Melbourne 225			x	x	x	x	x	x	x
	Melbourne 300			x	x	x	x	x	x	x

"x" indicates door-color combination is available

The numbers in the door name refer to the framing width of the door.  
 225 = 2-1/4" framing    275 = 2-3/4" framing    300 = 3" framing





# ALTERNATIVE MATERIALS

# ALUMINUM FRAME DOORS



## Alternative Materials Aluminum Frame Doors

Framed	Frameless	Plywood	Furniture Board	Plain Inset	Beaded Inset	Full Overlay	Matching Drawer Front	Radius Door	Standard Hood Front	Concealed Hinge	Standard R.P. Arched Valance	Available Painted	Wainscot
				NA	NA		NA	NA	NA		NA	NA	NA

**Notes:**

- 4 frame options available.
- Available in: Natural aluminum, black, oil rubbed bronze, brushed stainless steel, and white.
- AF003 also available in chrome and Arctic Gold
- 25 insert options for center panels
- Touch latches are recommended.
- Can be hinged as lift up door using Blum Aventos hinges.
- Drilling for decorative hardware is available. Requires detailed drawing.

Minimum Size: 6" w x 6" h      Maximum size: 96" and/or 10 sq ft.

Section Drawings of options available:

## Aluminum Frame Doors

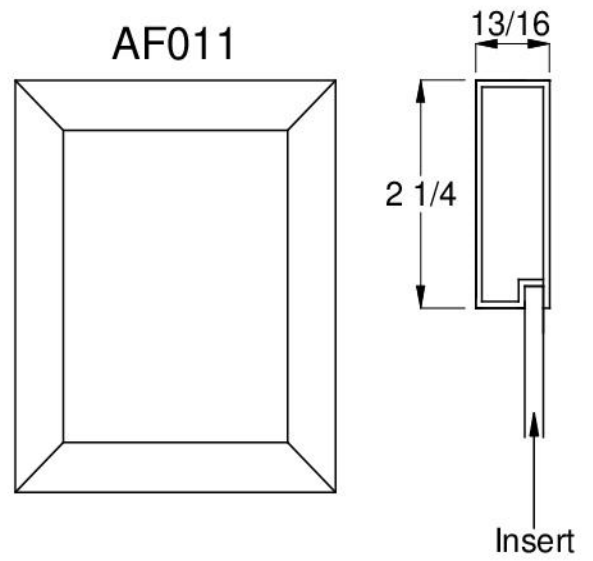
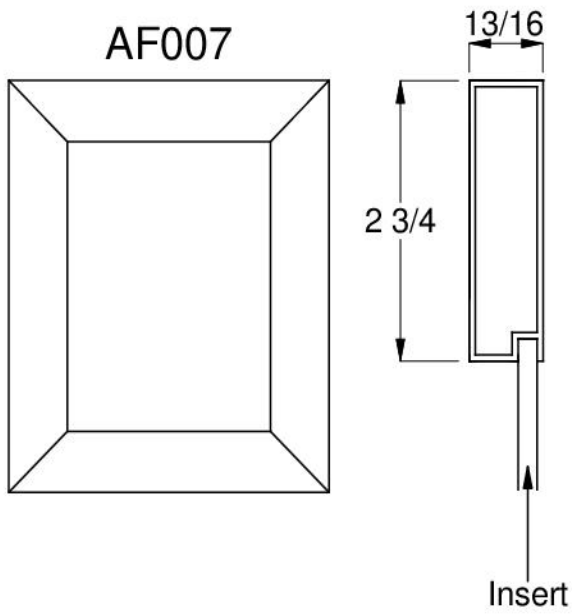
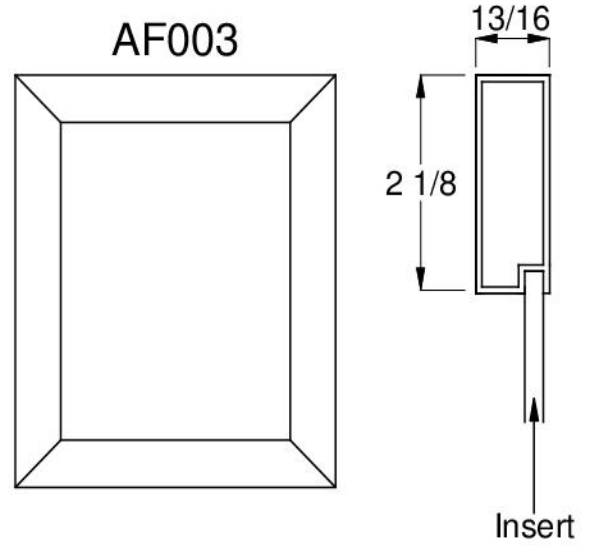
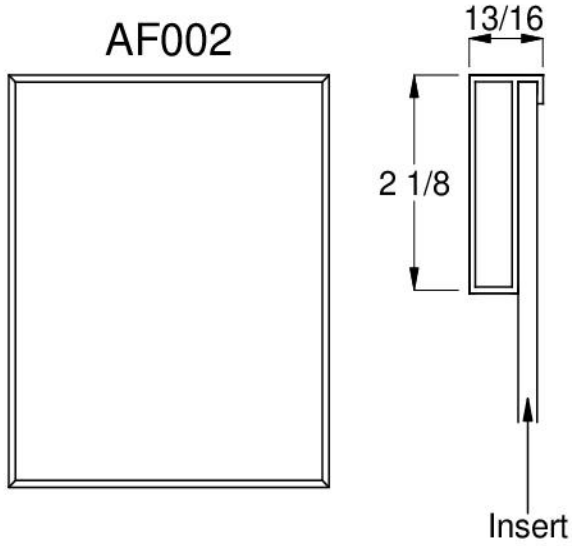



## NOTES



# ALTERNATIVE MATERIALS

# STRATA



## Alternative Materials Strata - Slab

Framed	Frameless	Plywood	Furniture Board	Plain Inset	Beaded Inset	Full Overlay	Matching Drawer Front	Radius Door	Standard Hood Front	Concealed Hinge	Standard R.P. Arched Valance	Available Painted	Wainscot
NA		NA		NA	NA			NA	NA		NA	NA	NA

**Notes:**

- Door - Vertical grain standard, horizontal grain available  
Sequential grain match available – max 48" x 96"
- Drawer Head – Horizontal grain standard  
Vertical grain available – sequential grain match recommended
- 1-lite glass door - uses 5 piece construction
- Not available with mullions
- Max size is 48" x 96".

Minimum Size: 2-3/4"w x 6-3/8"h

Section Drawings of options available:

Slab



Drawer Front  
match door framing

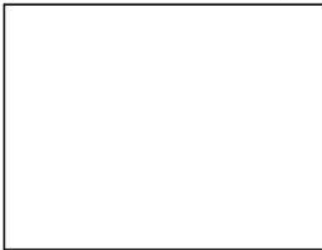

match door framing  
(see door detail above)



## Alternative Materials Strata - 3-Piece

Framed	Frameless	Plywood	Furniture Board	Plain Inset	Beaded Inset	Full Overlay	Matching Drawer Front	Radius Door	Standard Hood Front	Concealed Hinge	Standard R.P. Arched Valance	Available Painted	Wainscot
NA		NA		NA	NA			NA	NA		NA	NA	NA

**Notes:**

Horizontal grain on center panel, vertical grain on stiles.  
1-lite glass door uses 5 piece construction.

Minimum Size: 8-3/4"w x 5"h

Section Drawings of options available:



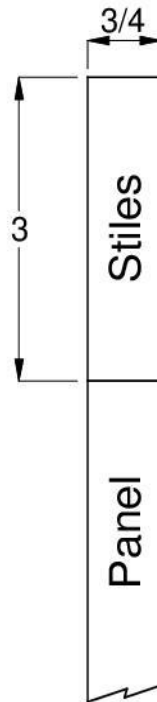
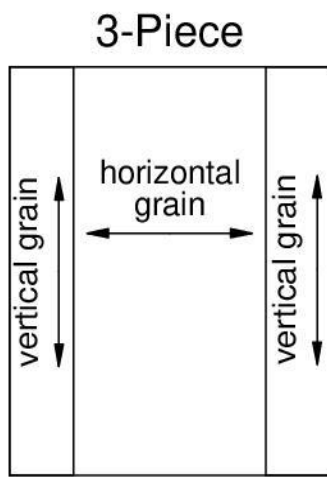

Drawer Front  
match door framing

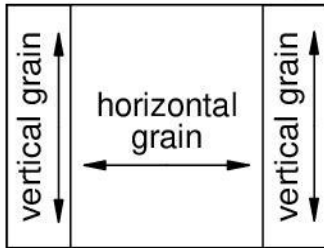

match door framing  
(see door detail above)



## Alternative Materials Strata - 5- Piece

Framed	Frameless	Plywood	Furniture Board	Plain Inset	Beaded Inset	Full Overlay	Matching Drawer Front	Radius Door	Standard Hood Front	Concealed Hinge	Standard R.P. Arched Valance	Available Painted	Wainscot
NA		NA		NA	NA			NA	NA		NA	NA	NA

**Notes:**

Door - Vertical grain on center panel is standard.  
 Horizontal grain is available.  
 Drawer Head – Horizontal grain standard  
 1-lite glass door uses 5 piece construction.  
 Not available with mullions

Minimum Size: 8-3/4" w x 7"h

Section Drawings of options available:



## Strata

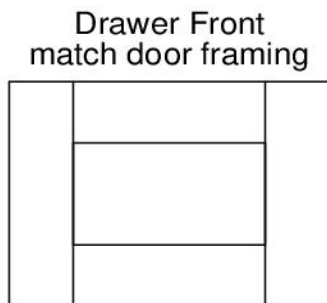
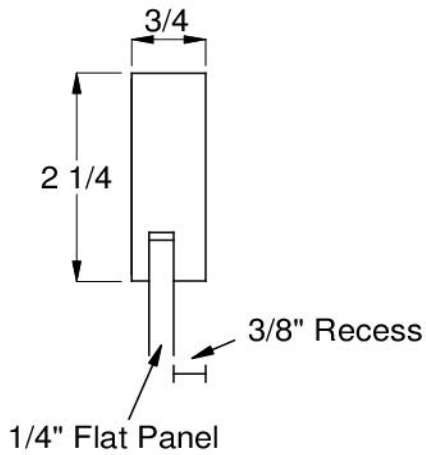
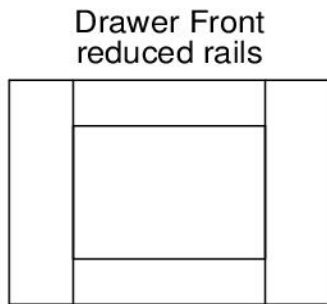
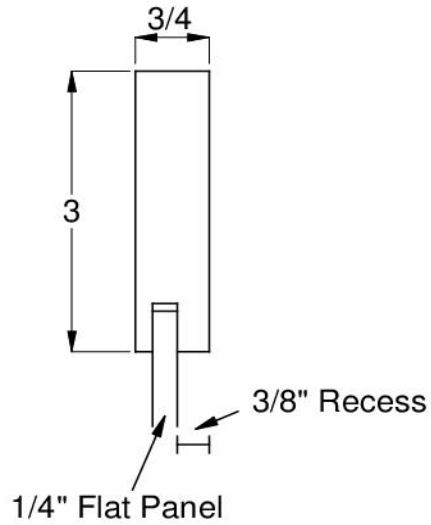
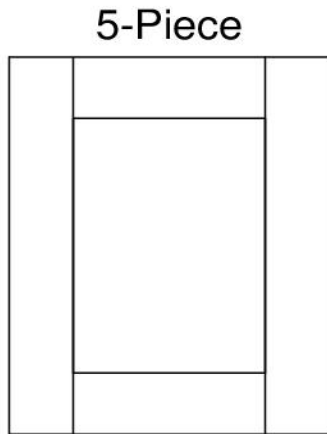

match door framing  
(see door detail above)



## NOTES



# ALTERNATIVE MATERIALS

# VOGUE



## Alternative Materials Vogue - Slab

Framed	Frameless	Plywood	Furniture Board	Plain Inset	Beaded Inset	Full Overlay	Matching Drawer Front	Radius Door	Standard Hood Front	Concealed Hinge	Standard R.P. Arched Valance	Available Painted	Wainscot
NA		NA		NA	NA			NA	NA		NA	NA	NA

Notes:

- Door - Vertical grain standard, horizontal grain available  
Sequential grain match available – max 48" x 96"
- Drawer Head – Horizontal grain standard  
Vertical grain available – sequential grain match recommended
- 1-lite glass door uses 5 piece construction
- Not available with mullions
- Max size is 48" x 96".

Minimum Size: 2-3/4"w x 6-3/8"h

Section Drawings of options available:

Slab



Drawer Front  
match door framing

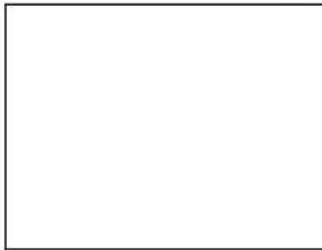

match door framing  
(see door detail above)



## Alternative Materials Vogue - 3-Piece

Framed	Frameless	Plywood	Furniture Board	Plain Inset	Beaded Inset	Full Overlay	Matching Drawer Front	Radius Door	Standard Hood Front	Concealed Hinge	Standard R.P. Arched Valance	Available Painted	Wainscot
NA		NA		NA	NA			NA	NA		NA	NA	NA

**Notes:**

Horizontal grain on center panel, vertical grain on stiles.  
1-lite glass door uses 5 piece construction.

Minimum Size: 8-3/4"w x 5"h

Section Drawings of options available:



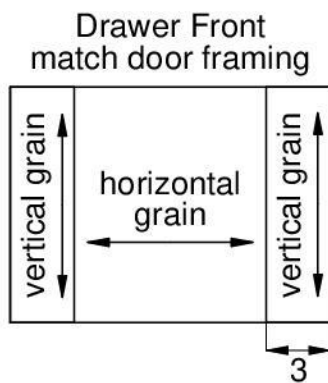
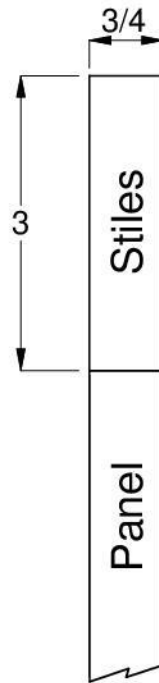
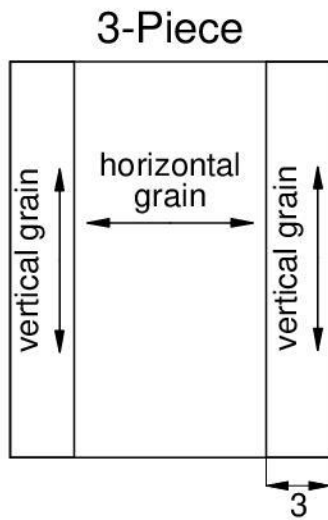

match door framing  
(see door detail above)



## Alternative Materials Vogue - 5-Piece

Framed	Frameless	Plywood	Furniture Board	Plain Inset	Beaded Inset	Full Overlay	Matching Drawer Front	Radius Door	Standard Hood Front	Concealed Hinge	Standard R.P. Arched Valance	Available Painted	Wainscot
NA		NA		NA	NA			NA	NA		NA	NA	NA

Notes:

- Door - Vertical grain on center panel is standard.  
Horizontal grain is available.
- Drawer Head – Horizontal grain standard
- 1-lite glass door uses 5 piece construction.
- Not available with mullions

Minimum Size: 8-3/4" w x 7" h

Section Drawings of options available:

5-Piece

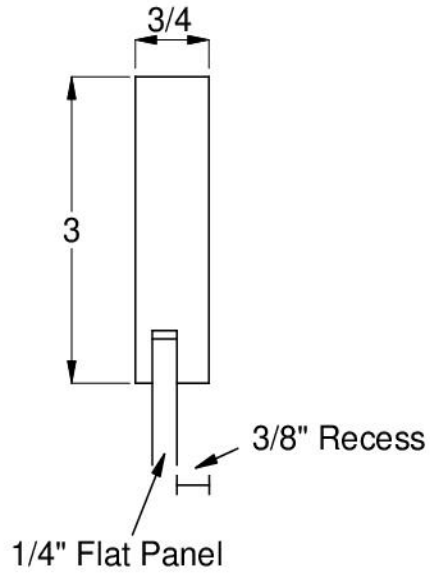
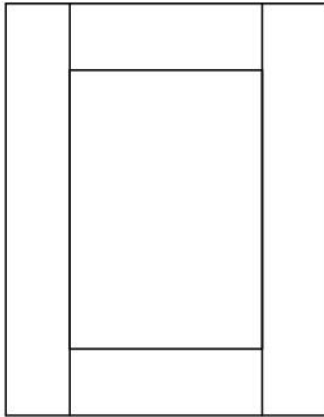

Drawer Front  
reduced rails

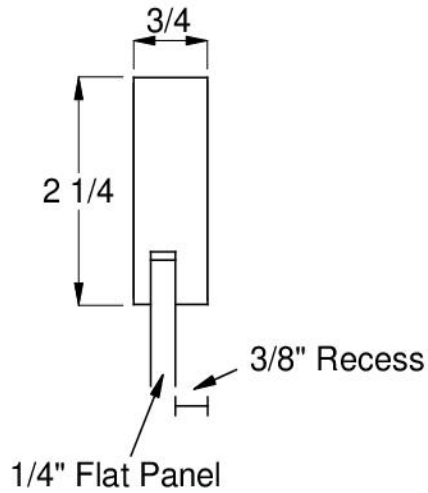
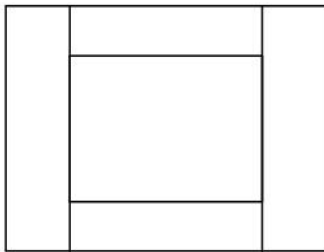

Drawer Front  
match door framing

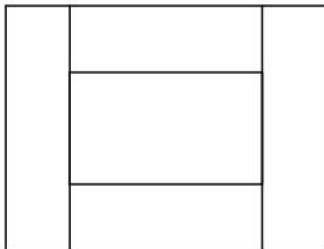

match door framing  
(see door detail above)



## NOTES



# ALTERNATIVE MATERIALS

# INTRIGUE



## Alternative Materials Intrigue - Slab

Framed	Frameless	Plywood	Furniture Board	Plain Inset	Beaded Inset	Full Overlay	Matching Drawer Front	Radius Door	Standard Hood Front	Concealed Hinge	Standard R.P. Arched Valance	Available Painted	Wainscot
NA		NA		NA	NA			NA	NA		NA	NA	NA

**Notes:**

- Door - Vertical grain standard, horizontal grain available
- Sequential grain match available – max 48" x 96"
- Drawer Head – Horizontal grain standard
- Vertical grain available – sequential grain match recommended
- 1-lite glass door uses 5 piece construction
- Not available with mullions
- Max size is 48" x 96".

Minimum Size: 2-3/4"w x 6-3/8"h

Section Drawings of options available:

## Intrigue

Slab

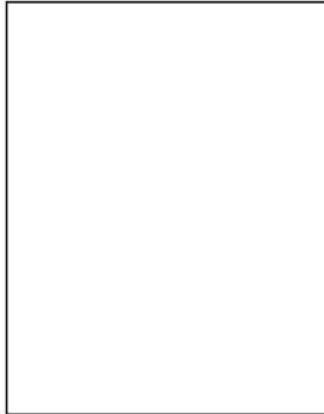

Drawer Front  
match door framing

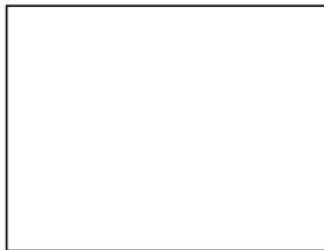

match door framing  
(see door detail above)



## Alternative Materials Intrigue - 3-Piece

Framed	Frameless	Plywood	Furniture Board	Plain Inset	Beaded Inset	Full Overlay	Matching Drawer Front	Radius Door	Standard Hood Front	Concealed Hinge	Standard R.P. Arched Valance	Available Painted	Wainscot
NA		NA		NA	NA			NA	NA		NA	NA	NA

**Notes:**

Horizontal grain on center panel, vertical grain on stiles.  
1-lite glass door uses 5 piece construction.

Minimum Size: 8-3/4"w x 5"h

Section Drawings of options available:



## Intrigue

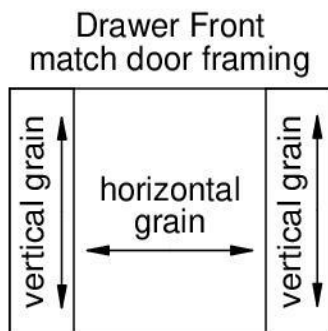
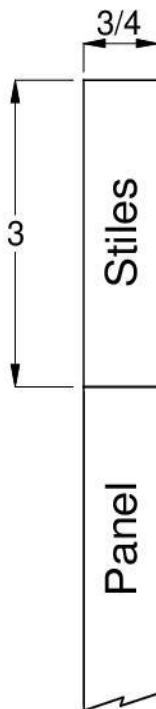
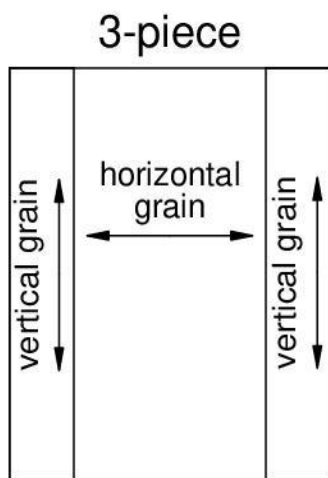

match door framing  
(see door detail above)



## Alternative Materials Intrigue - 5-Piece

Framed	Frameless	Plywood	Furniture Board	Plain Inset	Beaded Inset	Full Overlay	Matching Drawer Front	Radius Door	Standard Hood Front	Concealed Hinge	Standard R.P. Arched Valance	Available Painted	Wainscot
NA		NA		NA	NA			NA	NA		NA	NA	NA

Notes:

- Door - Vertical grain on center panel is standard.  
Horizontal grain is available.
- Drawer Head – Horizontal grain standard
- 1-lite glass door uses 5 piece construction.
- Not available with mullions

Minimum Size: 8-3/4”w x 7”h

Section Drawings of options available:

## Intrigue

5-piece

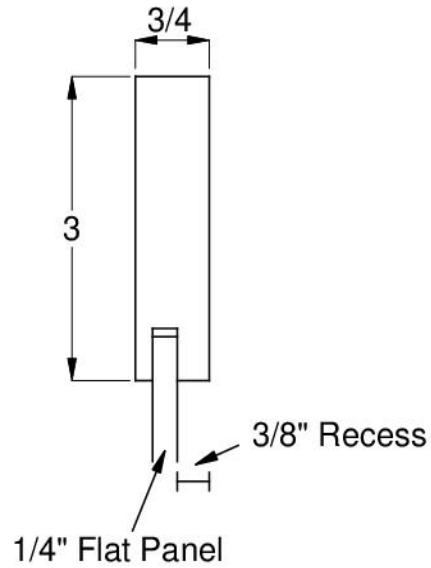
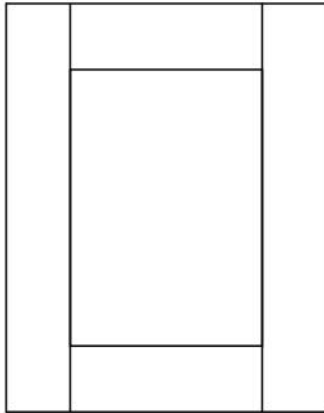

Drawer Front  
reduced rails

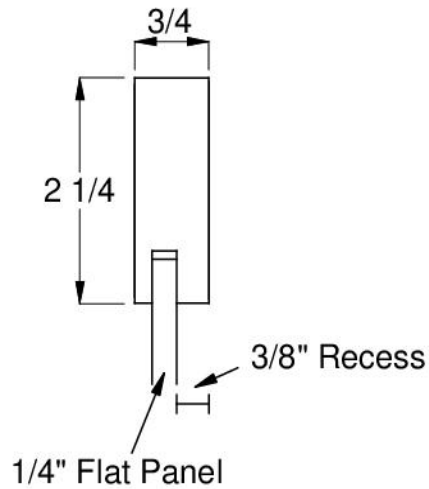
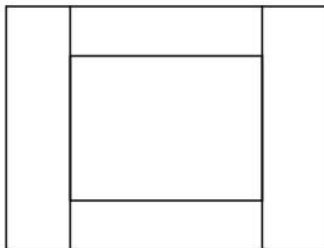

Drawer Front  
match door framing

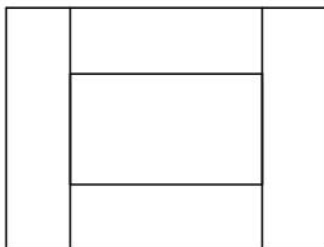

match door framing  
(see door detail above)



## NOTES



# ALTERNATIVE MATERIALS

# SYNCHRONICITY



## Alternative Materials

### Synchronicity - Super Matte Slab

<i>Framed</i>	<i>Frameless</i>	<i>Plywood</i>	<i>Furniture Board</i>	<i>Plain Inset</i>	<i>Beaded Inset</i>	<i>Full Overlay</i>	<i>Matching Drawer Front</i>	<i>Radius Door</i>	<i>Standard Hood Front</i>	<i>Concealed Hinge</i>	<i>Standard R.P. Arched Valance</i>	<i>Available Painted</i>	<i>Wainscot</i>
NA			NA	NA	NA			NA	NA		NA	NA	NA

**Notes:**

All matte products are shipped with a protective peel coat.  
 Peel coat eraser and matte care kit are suggested.  
 1-lite glass door available  
 Heat shield strips are suggested next to a range or oven

Minimum Size: 2-3/4" w x 6-3/8" h

Section Drawings of options available:

## Synchronicity

Super Matte Slab

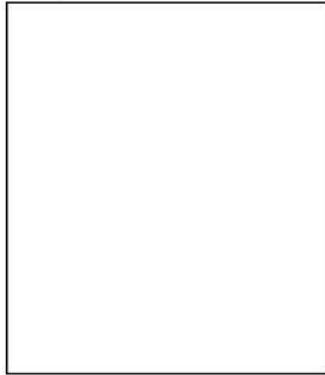

Drawer Front  
match door framing



match door framing  
(see door detail above)



## Alternative Materials Synchronicity - Mera Slab

<i>Framed</i>	<i>Frameless</i>	<i>Plywood</i>	<i>Furniture Board</i>	<i>Plain Inset</i>	<i>Beaded Inset</i>	<i>Full Overlay</i>	<i>Matching Drawer Front</i>	<i>Radius Door</i>	<i>Standard Hood Front</i>	<i>Concealed Hinge</i>	<i>Standard R.P. Arched Valance</i>	<i>Available Painted</i>	<i>Wainscot</i>
NA			NA	NA	NA			NA	NA		NA	NA	NA

**Notes:**

All high gloss products are shipped with a protective peel coat.  
 Peel coat eraser and high gloss care kit are suggested.  
 1-lite glass door available  
 Heat shield strips are suggested next to a range or oven.

Minimum Size: 2-3/4" w x 6-3/8" h

Section Drawings of options available:



## Synchronicity

Mera Slab

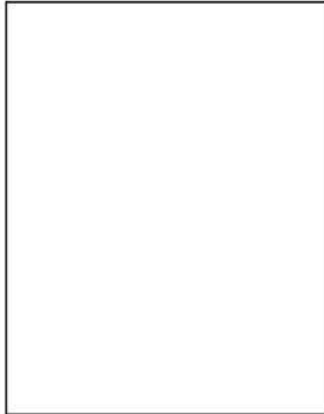

Drawer Front  
match door framing

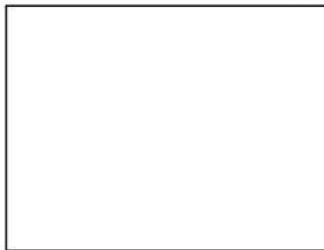

match door framing  
(see door detail above)



## Alternative Materials Synchronicity - Vetro Slab

Framed	Frameless	Plywood	Furniture Board	Plain Inset	Beaded Inset	Full Overlay	Matching Drawer Front	Radius Door	Standard Hood Front	Concealed Hinge	Standard R.P. Arched Valance	Available Painted	Wainscot
NA			NA	NA	NA			NA	NA		NA	NA	NA

**Notes:**

All high gloss products are shipped with a protective peel coat. Peel coat eraser and high gloss care kit are suggested.  
 1-lite glass door available  
 Heat shield strips are suggested next to a range or oven.

Minimum Size: 2-3/4"w x 6-3/8"h

Section Drawings of options available:

## Synchronicity

Vetro Slab

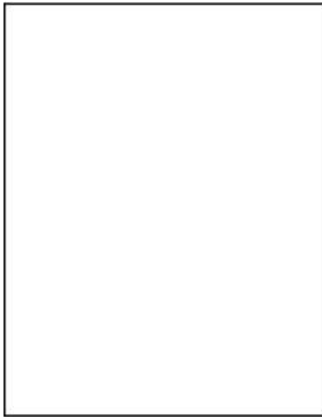

Drawer Front  
match door framing

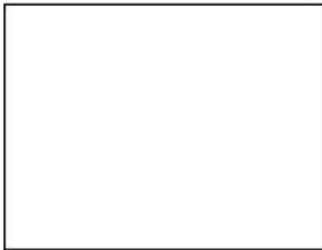

match door framing  
(see door detail above)



## NOTES



# WOOD DOOR DESIGN OPTIONS



## Edge Profiles

### Inset Edge Profiles:

Standard Inset Face Frame Edge Profiles:

Available as 3/4" or 1" face frames:

1" face frames: available with any 3/4" door with standard edge profile OR with 1" specialty doors with corresponding edge profile:



1/4" bead



3/8" bead



non-bead



V-bead



ogee bead



French Inset

Standard Inset Door Edge Profiles:

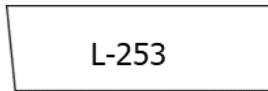

L-253

5 degree back bevel

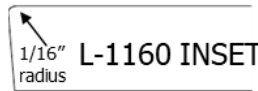

L-1160 INSET

5 degree back bevel



L-686

5 degree back bevel

Specialty 1" Inset Door Edge Profiles – available only with similar profile 1" face frame or with any 3/4" face frame profile :

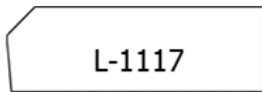

L-1117

5 degree back bevel

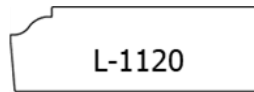

L-1120

5 degree back bevel

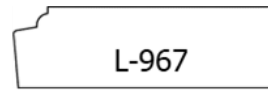

L-967

5 degree back bevel

### 3/8" Inset Edge Profiles:

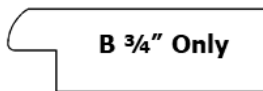

B 3/4" Only

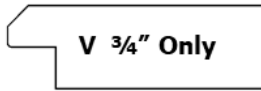

V 3/4" Only

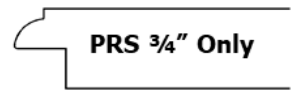

PRS 3/4" Only

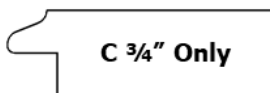

C 3/4" Only

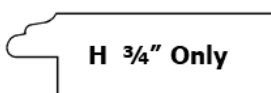

H 3/4" Only

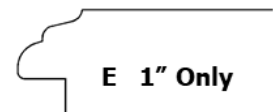

E 1" Only



## Edge Profiles

### Knife Hinge Edge Profiles and Specialty

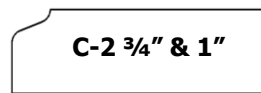
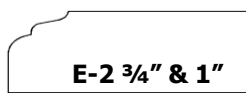
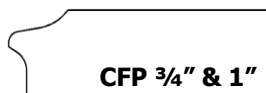
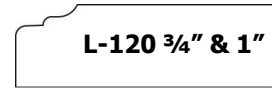
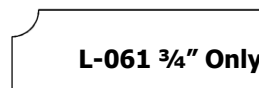
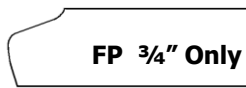
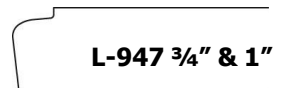
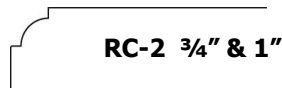
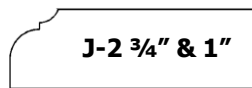
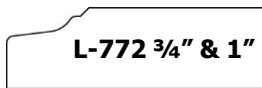

### Concealed Hinge or Knife Hinge Edge Profiles

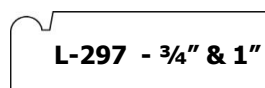
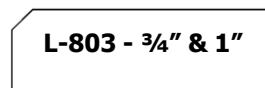
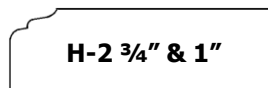
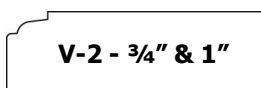
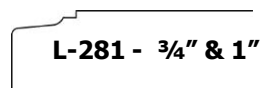
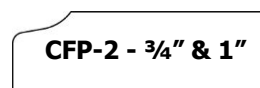
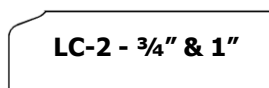
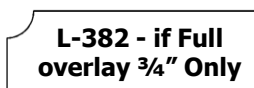
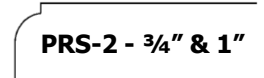
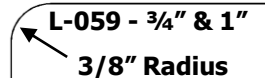
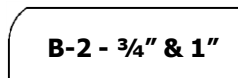
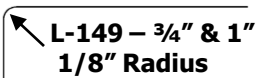
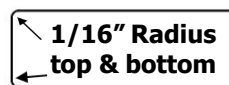
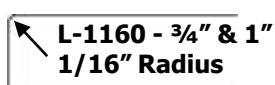
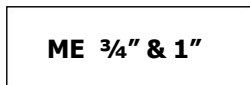

Up-charge per Door

Up-charge per Door



## STANDARD FRAMING BEADS FOR DOORS AND DRAWER FRONTS

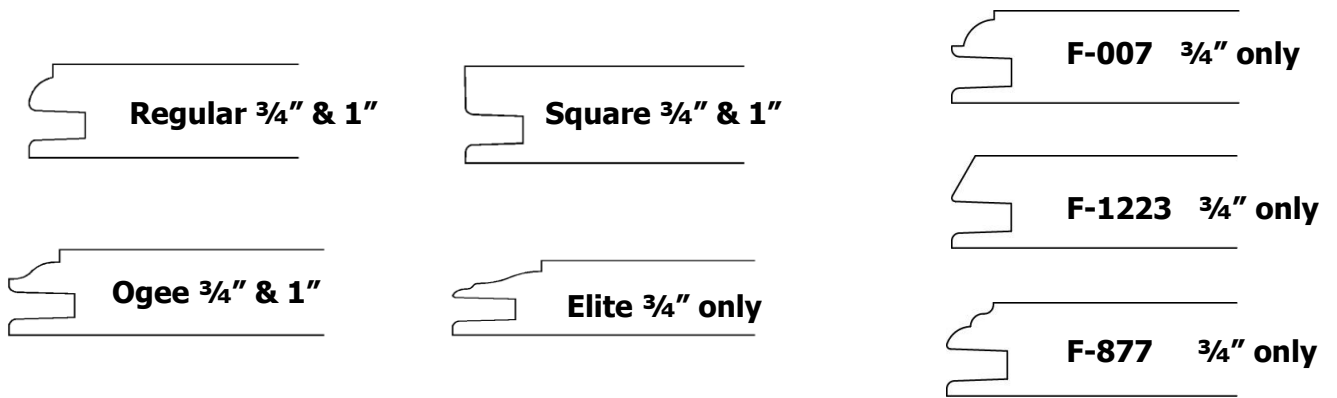

Not all framing beads are available with all door designs.  
 Design cost includes choice of framing bead.  
 Sample kits are available for edge profiles, framing beads and panel raises.

## SPECIALTY FRAMING BEADS FOR 3/4\"/>

FB 557

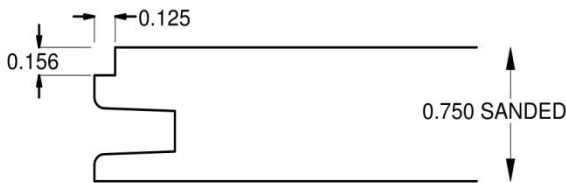

FB 722

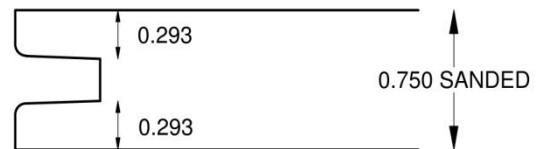

FB 792

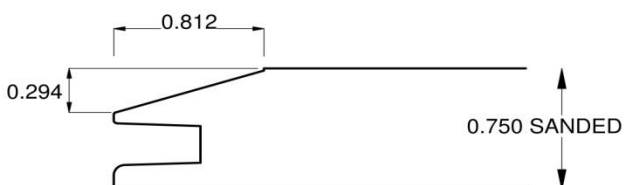

FB 1016

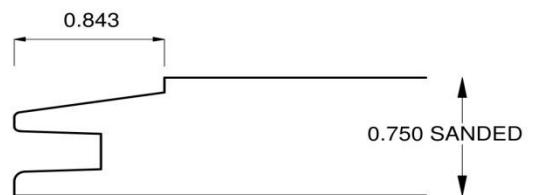





## SPECIALTY FRAMING BEADS FOR 1" THICK DOORS AND DRAWER FRONTS

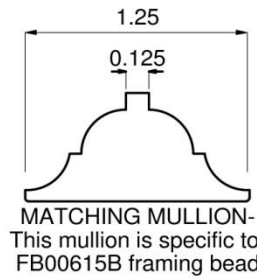
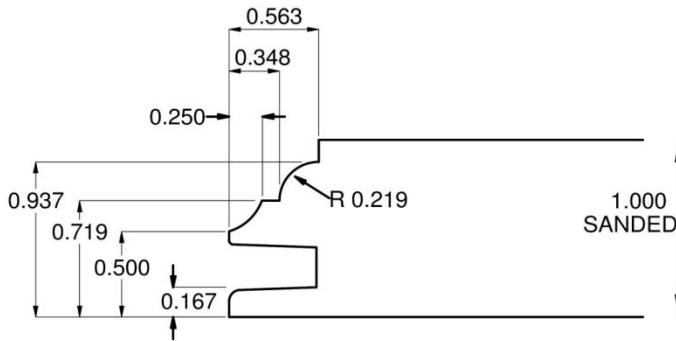

**FB 615**

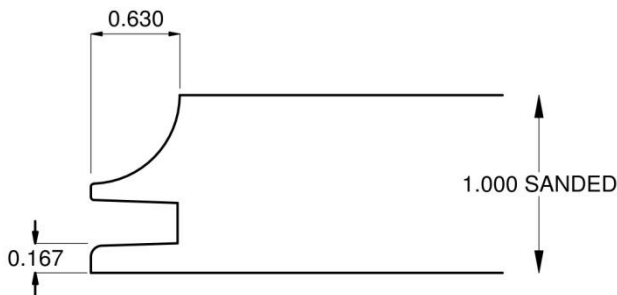

**FB 1370**

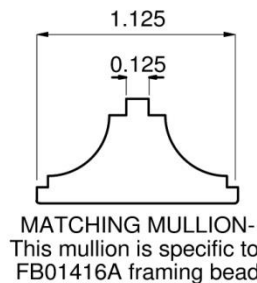
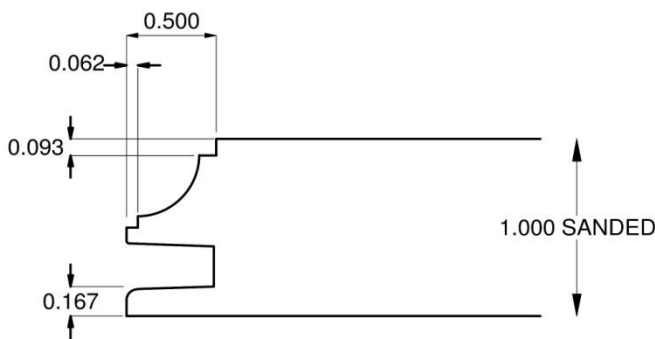

**FB 1416**



## Panel Raises

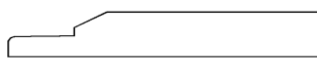

**Chamfer Raise #106**



**Slant Raise**  
**3/4" & 1" Doors**

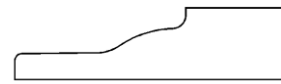

**RM Raise**  
**3/4" & 1" Doors**

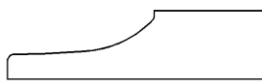

**G-Cove Raise**  
**3/4" & 1" Doors**



**TR Raise P095**

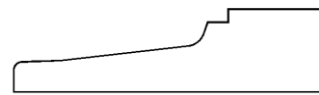

**Louis XIII Raise**  
**3/4" Doors Only**



**U-Cove Raise**  
**3/4" Doors Only**



**P008**  
**3/4" & 1" Doors**



**M-Bead Raise**  
**3/4" & 1" Doors**



**P602**  
**3/4" & 1" Doors**



**Rev G-Cove Raise**  
**3/4" & 1" Doors**

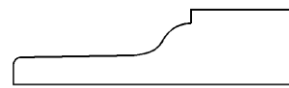

**Pres Raise**  
**3/4" Doors Only**



**P-Raise**  
**1" Doors Only**



**P057**  
**3/4" & 1" Drawers**

Not all panel raises are available with all door designs.

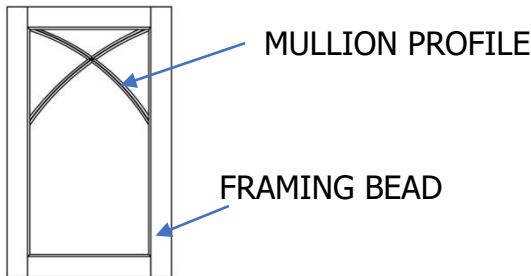

### DESIGN NOTE:

- Not all framing beads have a matching mullion profile available.
- Only the following framing beads have a matching mullion profile:
  - Regular
  - Ogee
  - Square
  - F-007
  - F-1223
- Elite and F-877 framing beads will get regular mullion profile

### Glass Retainer Molding

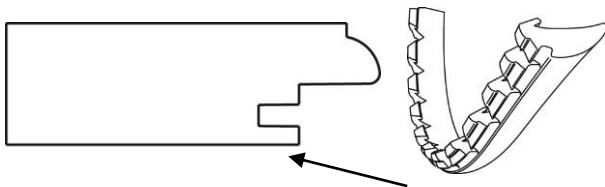

Mullion doors have a clear retainer molding as standard. It is sized for 1/8" glass thickness. For glass thicker than 1/8", use wood retainer molding below.



A wood retainer molding is used when glass thickness exceeds 1/8", or when the door is on a radius.

**Wood retainer molding is only available on doors with 2-3/4" framing or greater.**

Use modification: WOODRETAINER

### MULLION PROFILES

All mullion doors must have one of the five beads shown here. These beads will be on the center mullion strips only. Frame of door will be as shown in Door Selection Guide. For mullion door availability, see specific door style page. Arched lite and double arched lite are not available with the ogee mullion.

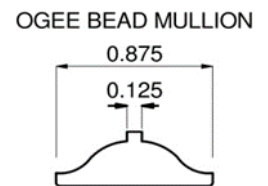
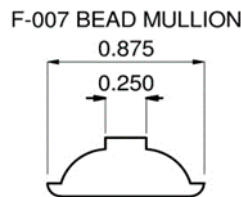
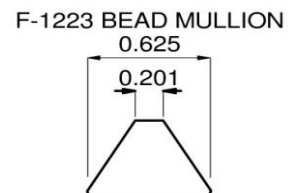
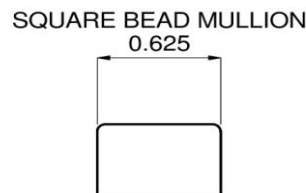
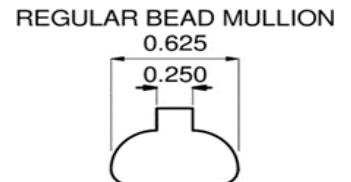
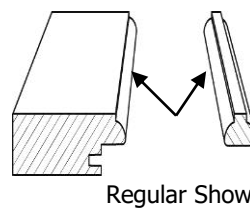

### GLASS OPTIONS

STANDARD 1/8" GLASS OPTIONS - listed in Advanceware:

- |                      |            |
|----------------------|------------|
| Clear                | Seeded     |
| German Antique clear | Tight Wave |
| Mirror               |            |

CUSTOM GLASS OPTIONS –

See your glass sample kit for available options. Contact the order desk for current pricing.



## Standard Lite Mullion Door

See exceptions p 1.241

1-LITE	8-LITE
4-LITE	10-LITE
6-LITE	12-LITE

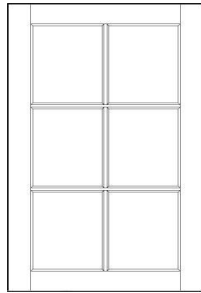

Specify 1,4,6,8,10 & 12 lite  
 All lites are spaced evenly unless otherwise requested  
 Minimum size of 7 7/8" x 7 7/8"  
 Clear retainer strip is standard.  
 True divided lite option is available on custom quote basis.  
 Prepped for glass thickness of 1/8".  
 Specify glass selection in QOE prompt.  
 Glass will be shipped installed in door.  
 Order these doors on the accessory line under the cabinet.  
 Be sure to include a finished interior modification if needed.

## 11 Lite Prairie Mullion Door

See exceptions p 1.241

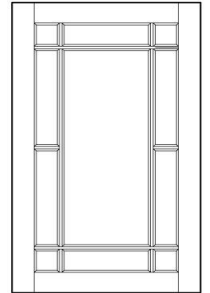

2" x 2" corner lites standard.  
 Minimum size of 11 7/8" x 14-5/8"  
 Clear retainer strip is standard.  
 True divided lite option is available on custom quote basis.  
 Prepped for glass thickness of 1/8".  
 Must order glass separately.  
 Glass will be shipped installed in door.  
 Order these doors on the accessory line under the cabinet.  
 Be sure to include a finished interior modification if needed.

11-LITEP

## Odyssey Mullion Door

See exceptions p 1.241

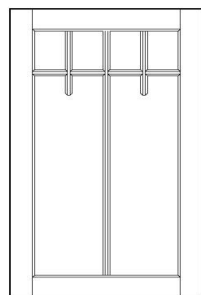

6-lite design with 2 mullion strips extending below horizontal  
 Minimum size of 14 7/8" x 11 3/8"  
 Clear retainer strip is standard.  
 True divided lite option is available on custom quote basis.  
 Prepped for glass thickness of 1/8".  
 Must order glass separately.  
 Glass will be shipped installed in door.  
 Order these doors on the accessory line under the cabinet.  
 Be sure to include a finished interior modification if needed.

ODYSSEY

## 9 Lite Prairie Mullion Door

See exceptions p 1.241

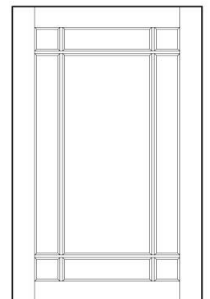

2" x 2" corner lites standard.  
 Minimum size of 11 7/8" x 11 7/8"  
 Clear retainer strip is standard.  
 True divided lite option is available on custom quote basis.  
 Prepped for glass thickness of 1/8".  
 Must order glass separately.  
 Glass will be shipped installed in door.  
 Order these doors on the accessory line under the cabinet.  
 Be sure to include a finished interior modification if needed.

9-LITEP



## Arched Lite Mullion Doors

See exceptions p 1.241

Ogee not available

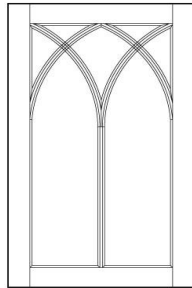

Features 7 radius lites  
 Minimum size of 11 5/8" x 9 5/8"  
 Clear retainer strip is standard.  
 True divided lite option is available on custom quote basis.  
 Prepped for glass thickness of 1/8".  
 Must order glass separately.  
 Glass will be shipped installed in door.  
 Order these doors on the accessory line under the cabinet.  
 Be sure to include a finished interior modification if needed.

ARCHED

## Double Arched Lite Mullion Doors

See exceptions p 1.241

Ogee not available

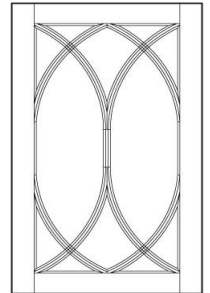

Features 12 radius lites  
 Minimum size of 11 5/8" x 14 15/16"  
 Clear retainer strip is standard.  
 True divided lite option is available on custom quote basis.  
 Prepped for glass thickness of 1/8".  
 Must order glass separately.  
 Glass will be shipped installed in door.  
 Order these doors on the accessory line under the cabinet.  
 Be sure to include a finished interior modification if needed.

DOUBLE - ARCHED

## Diamond Mullion Doors

See exceptions p 1.241

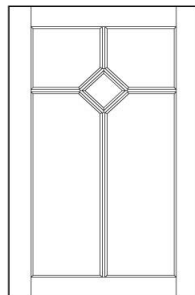

Features 4" x 4" diamond lite centered left and right  
 Starts 4 1/2" down from top rail.  
 Minimum size of 12 5/8" x 18 5/8"  
 Clear retainer strip is standard.  
 True divided lite option is available on custom quote basis.  
 Prepped for glass thickness of 1/8".  
 Must order glass separately.  
 Glass will be shipped installed in door.  
 Order these doors on the accessory line under the cabinet.  
 Be sure to include a finished interior modification if needed.

DIAMOND

## Double Diamond Mullion Doors

See exceptions p 1.241

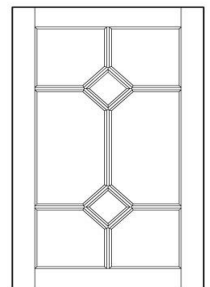

Features 4" x 4" diamond lite centered left and right  
 Starts 4 1/2" down from top rail, and 4 1/2" up from bottom.  
 Minimum size of 12 5/8" x 25-1/4"  
 Clear retainer strip is standard.  
 True divided lite option is available on custom quote basis.  
 Prepped for glass thickness of 1/8".  
 Must order glass separately.  
 Glass will be shipped installed in door.  
 Order these doors on the accessory line under the cabinet.  
 Be sure to include a finished interior modification if needed.

DOUBLE - DIAMOND



## Double Bow

See exceptions p 1.241



Features 4 radius lites  
 Minimum size of 11 5/8" x 11 5/8"  
 Clear retainer strip is standard.  
 True divided lite option is available on custom quote basis.  
 Prepped for glass thickness of 1/8".  
 Must order glass separately.  
 Glass will be shipped installed in door.  
 Order these doors on the accessory line under the cabinet.  
 Be sure to include a finished interior modification if needed.

DOUBLE BOW

## Double Bow Diamond

See exceptions p 1.241



Features radius and angular lites (12 total)  
 Minimum size of 11 5/8" x 14 15/16"  
 Clear retainer strip is standard.  
 True divided lite option is available on custom quote basis.  
 Prepped for glass thickness of 1/8".  
 Must order glass separately.  
 Glass will be shipped installed in door.  
 Order these doors on the accessory line under the cabinet.  
 Be sure to include a finished interior modification if needed.

DOUBLE BOW DIAMOND

## Vessica

See exceptions p 1.241



Features 7 radius lites  
 Minimum size of 8 5/8" x 15 15/16"  
 Clear retainer strip is standard.  
 True divided lite option is available on custom quote basis.  
 Prepped for glass thickness of 1/8".  
 Must order glass separately.  
 Glass will be shipped installed in door.  
 Order these doors on the accessory line under the cabinet.  
 Be sure to include a finished interior modification if needed.

VESSICA

## Half Vessica

See exceptions p 1.241

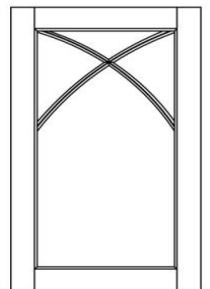

Features 4 radius lites  
 Minimum size of 8 5/8" x 12 5/8"  
 Clear retainer strip is standard.  
 True divided lite option is available on custom quote basis.  
 Prepped for glass thickness of 1/8".  
 Must order glass separately.  
 Glass will be shipped installed in door.  
 Order these doors on the accessory line under the cabinet.  
 Be sure to include a finished interior modification if needed.

HALF VESSICA



## Arched Horizontal

See exceptions p 1.241



Features 11 radius lites  
 Rectangular lites vary with door height  
 Minimum size of 11 5/8" x 9 5/8"  
 Clear retainer strip is standard.  
 Prepped for glass thickness of 1/8".  
 Must order glass separately.  
 Glass will be shipped installed in door.  
 Order these doors on the accessory line under the cabinet.  
 Be sure to include a finished interior modification if needed.

ARCHED HORIZONTAL

## Hourglass Diamond

See exceptions p 1.241

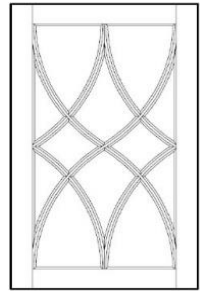

Features 12 radius lites  
 Minimum size of 11 5/8" x 14 15/16"  
 Clear retainer strip is standard.  
 Prepped for glass thickness of 1/8".  
 Must order glass separately.  
 Glass will be shipped installed in door.  
 Order these doors on the accessory line under the cabinet.  
 Be sure to include a finished interior modification if needed.

HOURLASS DIAMOND

## 20 Lite Double Diamond

See exceptions p 1.241

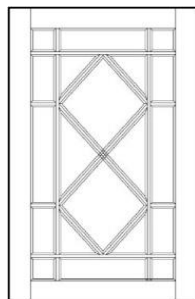

Features 20 lites with 2 diamond lites centered in door  
 Minimum size of 12 5/8" x 18 5/8"  
 Clear retainer strip is standard.  
 Prepped for glass thickness of 1/8".  
 Must order glass separately.  
 Glass will be shipped installed in door.  
 Order these doors on the accessory line under the cabinet.  
 Be sure to include a finished interior modification if needed.

20-LITE DOUBLE DIAMOND

## Elliptical Mullion

See exceptions p 1.241



Features elliptical shape in center of door  
 Minimum elliptical opening is 2-1/2" x 5"  
 Must specify size of elliptical opening  
 Minimum size of 12 5/8" x 13 5/8"  
 Clear retainer strip is standard.  
 Prepped for glass thickness of 1/8".  
 Must order glass separately.  
 Glass will be shipped installed in door.  
 Order these doors on the accessory line under the cabinet.  
 Be sure to include a finished interior modification if needed.

ELLIPTICAL MULLION



## X-Lite Mullion Door

See exceptions p 1.241



Diagonal mullion pattern  
 Minimum size of 8 5/8" x 8 5/8"  
 Clear retainer strip is standard.  
 Prepped for glass thickness of 1/8".  
 Must order glass separately.  
 Glass will be shipped installed in door.  
 Order these doors on the accessory line under the cabinet.  
 Be sure to include a finished interior modification if needed.

X-LITE

## X-Lite Solid Hub Mullion Door

See exceptions p 1.241



Features solid center hub  
 Hub diameter varies from 3" to 3-1/4" depending on framing bead  
 Minimum size of 9 5/8" x 9 5/8"  
 Clear retainer strip is standard.  
 Prepped for glass thickness of 1/8".  
 Must order glass separately.  
 Glass will be shipped installed in door.  
 Order these doors on the accessory line under the cabinet.  
 Be sure to include a finished interior modification if needed.

X-LITE SOLID HUB

## X-Lite Open Hub Mullion Doors

See exceptions p 1.241



Features open center hub.  
 Hub diameter varies from 3" to 3-1/4" depending on framing bead  
 Minimum size of 9 5/8" x 9 5/8"  
 Clear retainer strip is standard.  
 Prepped for glass thickness of 1/8".  
 Must order glass separately.  
 Glass will be shipped installed in door.  
 Order these doors on the accessory line under the cabinet.  
 Be sure to include a finished interior modification if needed.

DIAMOND

## X-Lite Panel Mullion Doors

See exceptions p 1.241

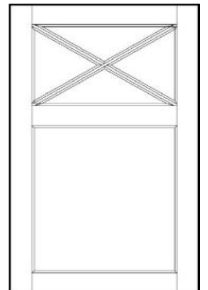

Features X-mullion top panel with solid lower panel  
 Minimum size of 8 5/8" x 15 5/8"  
 Clear retainer strip is standard.  
 Prepped for glass thickness of 1/8".  
 Must order glass separately.  
 Glass will be shipped installed in door.  
 Order these doors on the accessory line under the cabinet.  
 Be sure to include a finished interior modification if needed.

DOUBLE - DIAMOND





## Double X Mullion Doors

See exceptions p 1.241

Ogee not available



Features diagonal mullion pattern  
 Minimum size of 8-5/8" x 13-1/8"  
 Clear retainer strip is standard.  
 Prepped for glass thickness of 1/8".  
 Must order glass separately.  
 Glass will be shipped installed in door.  
 Order these doors on the accessory line under the cabinet.  
 Be sure to include a finished interior modification if needed.

ARCHED

## Double X Horizontal Mullion Doors

See exceptions p 1.241

Ogee not available



Features diagonal mullion pattern  
 Minimum size of 8-5/8" x 13-1/8"  
 Clear retainer strip is standard.  
 Prepped for glass thickness of 1/8".  
 Must order glass separately.  
 Glass will be shipped installed in door.  
 Order these doors on the accessory line under the cabinet.  
 Be sure to include a finished interior modification if needed.

DOUBLE - ARCHED

## Triple X Mullion Doors

See exceptions p 1.241



Features diagonal mullion pattern  
 Minimum size of 8-5/8" x 17-3/4"  
 Clear retainer strip is standard.  
 Prepped for glass thickness of 1/8".  
 Must order glass separately.  
 Glass will be shipped installed in door.  
 Order these doors on the accessory line under the cabinet.  
 Be sure to include a finished interior modification if needed.

DIAMOND

## Triple X Horizontal Mullion Doors

See exceptions p 1.241



Features diagonal mullion pattern  
 Minimum size of 8-5/8" x 17-3/4"  
 Clear retainer strip is standard.  
 Prepped for glass thickness of 1/8".  
 Must order glass separately.  
 Glass will be shipped installed in door.  
 Order these doors on the accessory line under the cabinet.  
 Be sure to include a finished interior modification if needed.

DOUBLE - DIAMOND



## Soji Mullion Doors

See exceptions p 1.241

Ogee not available

Features rectangular lites  
Horizontal mullions only  
Minimum size of 11 5/8" x 9 5/8"  
Clear retainer strip is standard.  
Prepped for glass thickness of 1/8".  
Must order glass separately.  
Glass will be shipped installed in door.  
Order these doors on the accessory line under the cabinet.  
Be sure to include a finished interior modification if needed.



2 LITE SOJI



3 LITE SOJI



4 LITE SOJI



5 LITE SOJI



6 LITE SOJI



## Quarter Circle Doors with Square Top

Minimum width of 9 1/2"  
 Minimum height of width plus 2 1/2".  
 Order these doors on the accessory line  
 under the cabinet.

### Mullion Doors

Clear retainer strip is standard.  
 True divided lite option is available on  
 custom quote basis.  
 Prepped for glass thickness of 1/8".  
 Must order glass separately.  
 Glass will be shipped installed in door.  
 Order these doors on the accessory line  
 under the cabinet.  
 Be sure to include a finished interior  
 modification if needed.

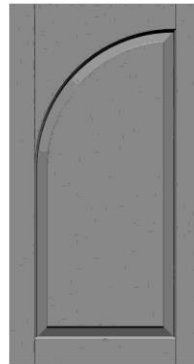

QC1000RP

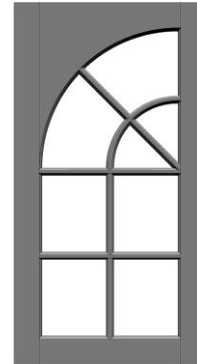

QC1000

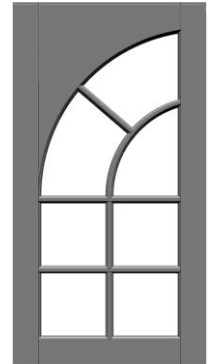

QC2000

*Available to match Alexandria, Columbus, Augusta, Washington, Olympia, Quaker, Amesbury, Shaker, Franklin, and Prestwick.*

## Quarter Circle Doors with Radius Top

Minimum width of 9 1/2"  
 Minimum height of width plus 2 1/2".  
 Order these doors on the accessory line  
 under the cabinet.

### Mullion Doors

Clear retainer strip is standard.  
 True divided lite option is available on  
 custom quote basis.  
 Prepped for glass thickness of 1/8".  
 Must order glass separately.  
 Glass will be shipped installed in door.  
 Order these doors on the accessory line  
 under the cabinet.  
 Be sure to include a finished interior  
 modification if needed.

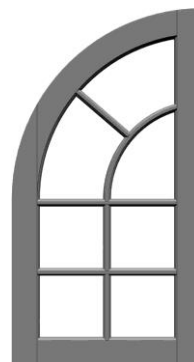

QC3000

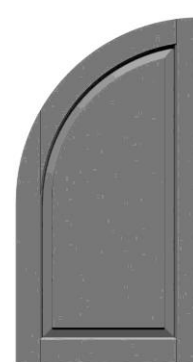

QC3000RP

*Available to match Alexandria, Columbus, Augusta, Washington, Olympia, Quaker, Amesbury, Shaker, Franklin, and Prestwick.*

**These doors require a custom cabinet.  
 Face frame opening will be on a radius.  
 Inset and beaded inset are available.  
 A drawing must be submitted for a quote.**



## Cathedral Door Option

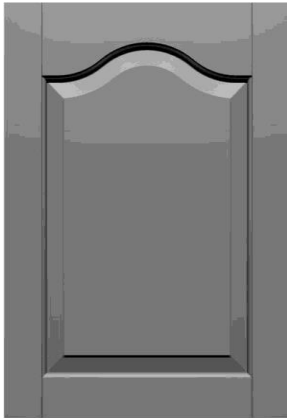

Available on all Level I doors except Astoria. When selected, it is standard on all upper doors of wall and tall cabinets. Per door charge.

## Arch Door Option

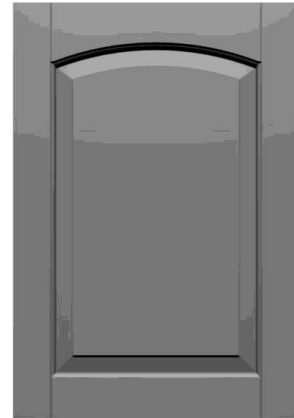

Available on all Level I doors except Astoria. When selected, it is standard on all upper doors of wall and tall cabinets. Per door charge.

## Miter Door Option

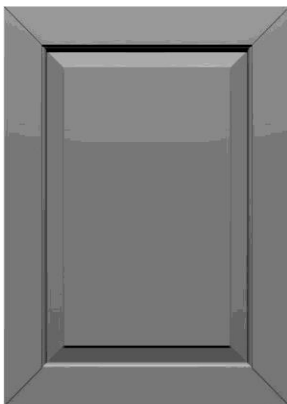

Available on all Level I doors except Astoria. When selected, it will appear on all doors. Use this option to eliminate the visible end grain of the stiles. Per door charge.

## Half Arch Door Option

HR20 shown

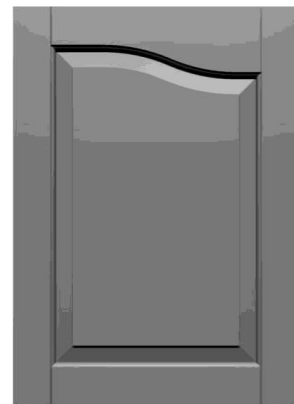

Available on all Level I doors except Astoria. You must specify where these doors are to be used. They can be used in pairs (right shown) on double door cabinets or wainscot panels. Apply by using HR20 / HL20 modification. Per door charge.



## Back Routed Hand Pull

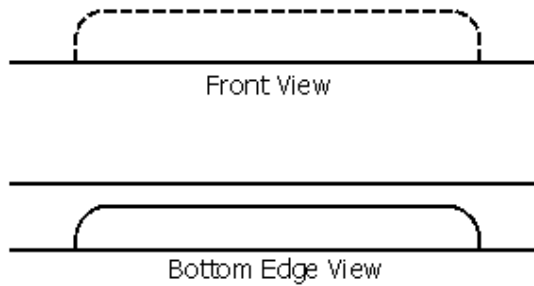
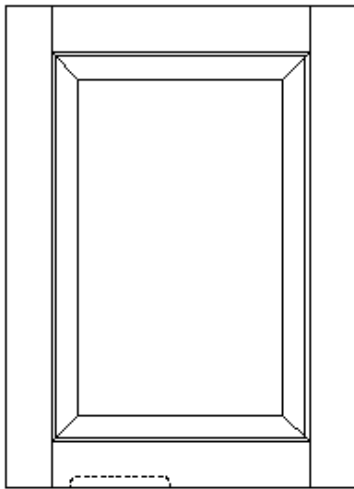

**per door charge**

Specify location: top or bottom and left, right or centered.  
 Rout is 3-5/8" wide and 3/8" deep. When specifying left or right hand, pull will start 3" in from edge of door.  
 Hand pull is centered on doors less than 10" wide.  
 Not available on 3/8" Inset, Beaded Inset, or Plain Inset.

## Face Routed Hand Pull

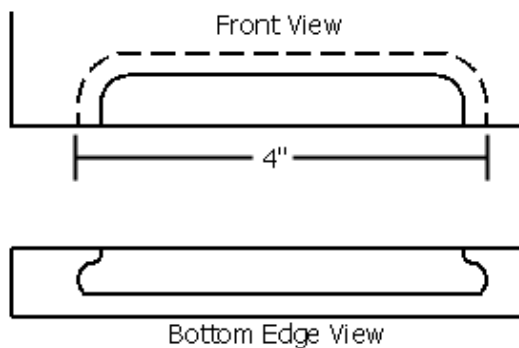
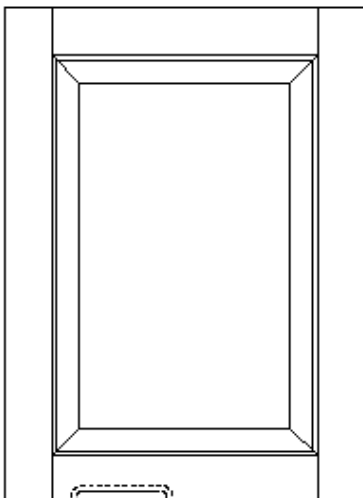

**per door charge**

Specify location: top or bottom and left, right or centered.  
 Rout is 4" wide and 1/2" deep. When specifying left or right hand, pull will start 3" in from edge of door.  
 Hand pull is centered on doors less than 10" wide.  
 Not available on 3/8" Inset, Beaded Inset, or Plain Inset.  
 Not available on the Washington or Astoria doors.



## Rout Options

### G-012 Rout

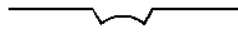
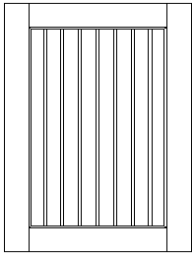

Groove Width: 1/4"  
Groove Depth: 1/16"

1-1/2" spacing from center of groove to center standard.  
Groove pattern begins from center of panel.  
Custom spacing available.  
Per panel charge.

### G-056 Rout

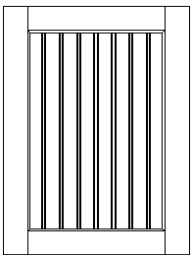

Groove width: 3/8"  
Groove depth: 1/8"

1-1/2" spacing from center of groove to center standard.  
Groove pattern begins from center of panel.  
Custom spacing available.  
Per panel charge.

### G-142 Rout

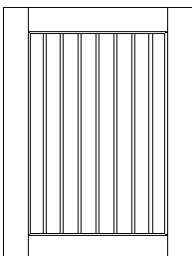

Groove width: 1/4"  
Groove depth: 1/16"

1-1/2" spacing from center of groove to center standard.  
Groove pattern begins from center of panel.  
Custom spacing available.  
Per panel charge.

### G-015 Rout

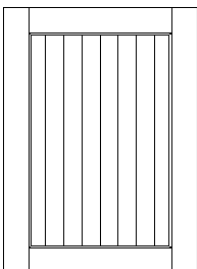

1-1/2" spacing

1-1/2" spacing from center of groove to center standard.  
Groove pattern begins from center of panel.  
Per panel charge.

### Camelot Rout

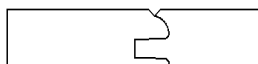
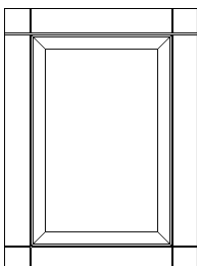

Grooves are on stiles and rails.  
Groove pattern begins from center of panel.  
Custom spacing available.  
A stile only groove is available as an option.  
Must be specified when ordering.  
Cannot be used with Madison, Austin, applied molding or mitered designs.  
Per panel charge.



## Peg Options

### 5/8" Raised Pegs

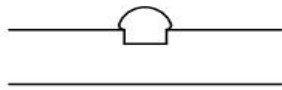
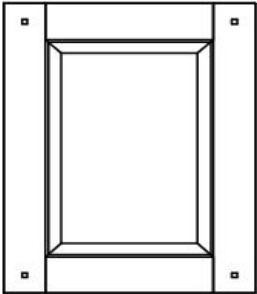

Specify quantity and locations. If location is not specified, pegs will be located 1-3/16" from inside of framing bead to center of peg. Available in White Birch only. Add 2 days to lead time. Per door charge.

### 5/16" Square Pegs

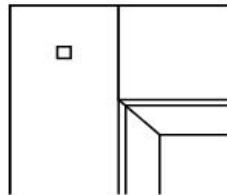
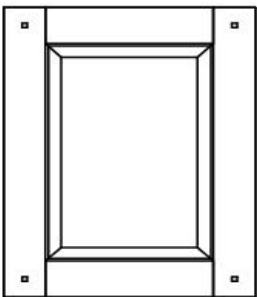

Specify quantity, location and specie. If location is not specified, pegs will be located 1-3/16" from inside of framing bead to center of peg. Any standard specie available. Add 2 days to lead time. Per door charge.

### 1/2" Round Pegs

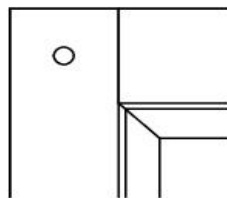
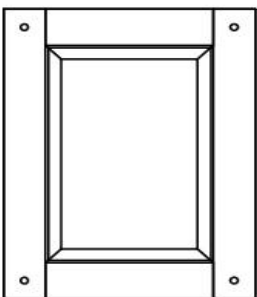

Specify quantity, location and specie. If location is not specified, pegs will be located 1-3/16" from inside of framing bead to center of peg. Available in Red Oak, Cherry, Walnut or White Birch. Add 2 days to lead time. Per door charge.

### 203 Routed Peg

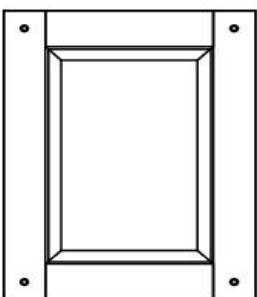

Center of rout is placed 1-3/16" from inside of framing bead. Add 2 days to lead time. Per door charge.



## Distressing



Rendering represents example only.  
 Distressing is a random treatment;  
 Appearance of distressing will vary from piece to piece.  
 A physical sample should be purchased before placing an order.

Description of Levels	
<b>Level 1</b>	A random distribution of nicks and impressions.
<b>Level 2</b>	A random distribution of nicks and impressions, plus simulated worm holes, razor cuts and cut joints.
<b>Level 3</b>	A random distribution of nicks and impressions, simulated wormholes plus powder beetle damage, rasp marks and cracks.

**\*Plywood will not be distressed. We recommend wainscot finished ends.**

## Antiquing (Rub-Thru)

Antiquing is a post-stain random sanding of corners and edges exposing the natural wood which is then varnished. This gives the effect of the stain color being rubbed through to expose the natural wood color. It provides a worn look to complement one of our distressing packages. Combine this with the wear sanding option to achieve a heavier level of antiquing.

Per door charge.

## Wear Sanding

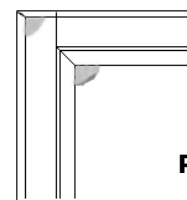

**Per door charge**

This option provides an aged appearance to unfinished doors and drawer fronts.

On raised panel designs, sanding is applied to the corners of the panel and the outside corner of the framing.

Flat panel, mullions and frame only designs will receive sanding on the outside corners of the frame only. Sanding will be random and each corner will vary with appearance.

Wear sanding is available with all published panel raises and edge profiles.

The wear sanding option is available as a stand alone feature and is also offered with distressing as described above.

## Radius Corners

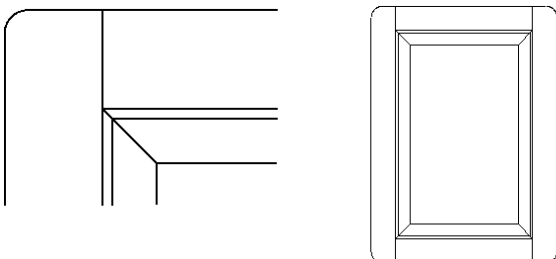

Specify 1/8", 1/4", 1/2", or 1" radius.  
 Available with B-2, C-2, LC-2, L-059, O, L149, machine edge and PRS-2 edge profiles only.

Per door charge





## Distressing & Antiquing

There are different levels of distressing and antiquing available to suit your customer's needs. Custom distressing or antiquing is not available. We offer only our standardized interpretation of these treatments. We recommend not using a sample chip to sell distressed or antiqued cabinetry. Please order a sample door for your customer's approval.

### Where distressing and antiquing occur:

Distressing and antiquing typically occur on the doors and drawer heads of the cabinetry. There are some cases where the different treatments are found on the cabinet face frames and moldings. The type of door style is the determining factor.

### Overlay Styles

- No distressing on face frames
- No antiquing on face frames
- Distressing on hardwood moldings
- Antiquing on the edges of the hardwood moldings

### Plain Inset & Beaded Inset Styles

- Distressing occurs on face frames and all hardwood molding.
- Antiquing occurs on inside corners of face frame and edges of hardwood molding.

### Important information about distressing and antiquing:

Finished sides and back panels will not receive distressing or antiquing. A guideline for this is: if it is plywood, then there is no distressing or antiquing.

If you desire antiquing or distressing on the finished sides and back panels you will need to order either an applied door or a wainscot side. (See p. 0.42-0.43) for the different types of wainscot).

Keep in mind that distressing and antiquing are random applications designed to convey an aged appearance. Most distress marks will not typically appear on the raised panel portion of doors or drawer heads.

The extent to which a distressing level impacts the look of the finished product will vary depending on wood species, door style, and the selected finish. **Please order a sample door for your customer's approval.**

**Remember: all treatments are random.**

**Typically, there will not be any treatment on the panel raise.**



## WEATHERED GRAIN OPTION

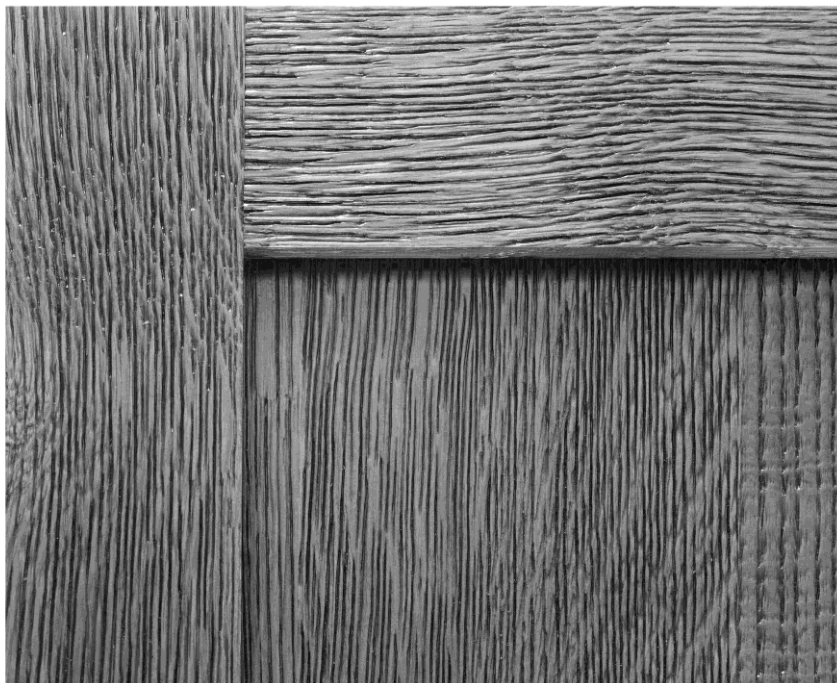

The weathering treatment is available on Quarter Sawn White Oak only. This treatment removes softer portions of the wood surface to give a highly textured look and feel. Framing beads and center panel grooves will be smooth. Only the face and outside edge of the doors and drawer fronts will be weathered. The weathered grain treatment is only available on the following edges: ME, L-1160, L-034 and L-149 (see p. 1.235). Available door styles are Bristol, Dover, Olympia, Quaker, Alexandria, Amesbury, Shaker, Stockholm, Prestwick and Crossbuck. Square Recessed and Square Raised are also be used but not all options are available. (See above or contact the Order Desk to confirm availability of your selections.) Plain inset is available and will have weathered face frames.

Stained finishes will have greater variation because the product cannot be sanded after the weathering process. A 5° flat sheen top coat is standard, with an option for a 15° low sheen.

The following 8' moldings are available weathered: B09 beaded panel, #13 batten, #14 scribe, #381 baseboard, #538 Shaker crown, 31126 Shaker crown, #1529 reverse Shaker crown, #1809 scribe, #2316 scribe, #2317 scribe. Plywood parts are not available with the weathering treatment.